

*Thank you for choosing*

# Panasonic Omnivision **VHS**

Video Cassette Recorder

**MODEL PV-8450**

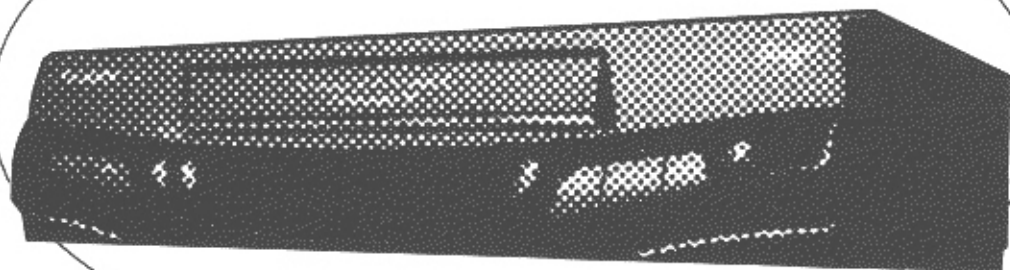

## Operating Instructions

Please read these instructions carefully before attempting to connect, operate or adjust this product. Please save this manual.

Spanish Quick Use Guide is included. (Guía para rápida consulta en español está incluido.)

**Quick Use Guide is on the back cover.**

P6 ~ P9  
Connections

P10 ~ P15  
Getting Started

P16 ~ P19  
Basic Operation

P20 ~ P30  
More You Can Do

P31 ~ Back Cover  
Other Information

# Things You Should Know

## Congratulations

on your purchase of one of the most sophisticated and reliable products on the market today. Used properly, it will bring you and your family years of enjoyment. Please fill in the information at right. The serial number is on the tag located on the back of your VCR.

Date of Purchase \_\_\_\_\_  
Dealer Purchased From \_\_\_\_\_  
Dealer Address \_\_\_\_\_  
Dealer Phone No. \_\_\_\_\_  
Model No. **PV-8450** \_\_\_\_\_  
Serial No. \_\_\_\_\_

## Safety Precautions

**Warning:** To prevent fire or shock hazard, do not expose this equipment to rain or moisture.

**CAUTION:** To prevent electric shock, match wide blade of plug to wide slot, fully insert.

This video recorder, equipped with the HQ (High Quality) System, is compatible with existing VHS equipment. Only use those tapes with the **VHS** mark. It is recommended that only cassette tapes that have been tested and inspected for use in 2, 4, 6, and 8 hour VCR machines be used.

FCC Warning: Any unauthorized changes or modifications to this equipment would void the user's authority to operate.

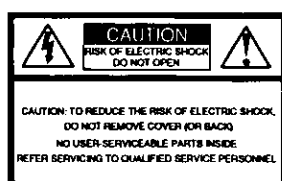

This symbol warns the user that uninsulated voltage within the unit may have sufficient magnitude to cause electric shock. Therefore, it is dangerous to make any kind of contact with any inside part of this unit.



This symbol alerts the user that important literature concerning the operation and maintenance of this unit has been included. Therefore, it should be read carefully in order to avoid any problems.

## Table of Contents

Important Safeguards and Precautions .....	3
Unpacking Your VCR • Product Features .....	4
VCR and Cassette Information (Record Tab, Tape Speeds, Head Cleaning, DST., Specifications) .....	5

### Connections

Basic Connection (Antenna and VCR, VCR and TV) .....	6, 7
Other Connections (CABLE, Audio/Video) .....	8, 9

### Getting Started

Location of Controls (Remote Control, VCR) .....	10, 11
One Time VCR Setup (On-Screen Language, Channel Memory, Clock Set) .....	12 ~ 14
On-Screen Displays (OSD) (Function, Channel, Menu, VCR Status & Clock, Warning) .....	15

### Basic Operation

Playback a Tape (Main Operation, Special Effects, Quality Picture Features) .....	16
Record On a Tape (Main Operation, One Touch Record, Channel Selection) .....	17
Timer Recording (Main Operation, Cancel, Clear or Replace Program Contents) .....	18, 19

### More You Can Do

Special VCR Features (Channel Caption, Time Stamp, Blue back ON/OFF, VCR Lock, Warning Beeper) ...	20 ~ 22
Tape Operation (Repeat Play, One Minute Skip, Zero Search, Auto Functions, Index Search) .....	23 ~ 25
MTS Broadcast/ VHS Hi-Fi Stereo System (Stereo/SAP/Mono Broadcast, Select Audio Mode) .....	26, 27
Multi-Brand Control Feature .....	28, 29
Copying Your Tapes (Dubbing) (Connection, Main Operation, Monitoring, Select Input Mode) .....	30

### Other Information

Before Requesting Service (Self-check items) .....	31
Service Center List .....	32
Warranty .....	33
Spanish Quick Use Guide .....	34, 35
Quick Use Guide .....	Back Cover



# Important Safeguards and Precautions

**FOR YOUR SAFETY, READ AND RETAIN ALL SAFETY AND OPERATING INSTRUCTIONS. HEED ALL WARNINGS IN THE MANUAL AND ON THE UNIT**

## INSTALLATION

### 1 POWER SOURCE CAUTION

Operate only from a power source indicated on the unit or in this manual. If necessary, have your Electric Utility Service Company or Video Products Dealer verify the power source in your home.

### 2 POLARIZED OR GROUNDING PLUG

As a safety feature, this Video product comes with either a polarized power cord plug (one blade is wider than the other), or a three-wire grounding type plug.

#### POLARIZED PLUG CAUTION:

This plug will only fit into an outlet one way. If you cannot fully insert the plug, try reversing it. If it still will not fit, have an electrician install the proper wall outlet. Do not defeat the safety feature by tampering with the plug.

#### GROUNDING PLUG CAUTION:

This plug will only fit into a three-hole grounding outlet. If necessary, have an electrician install the proper outlet. Do not defeat the safety feature by tampering with the plug.

### 3 POWER CORD

Make sure power cords are routed so that they are not likely to have anything rest on them, roll over them, or be in the way of walking traffic.

If an extension cord is used, make sure it also has either a polarized or grounded plug and that the cords can be securely connected.

Frayed cords, damaged plugs, and damaged or cracked wire insulation are hazardous and should be replaced by a qualified service technician.

Overloaded outlets and extension cords are fire hazards and should be avoided.

### 4 DO NOT BLOCK VENTILATION HOLES

Ventilation openings in the cabinet release heat generated during operation. If they are blocked, heat build-up inside the unit can cause failures that may result in a fire hazard or heat damage to cassettes.

For protection, follow these rules:

- Never cover ventilation slots or the unit while in use, or operate the unit when placed on a bed, sofa, rug, or other soft surface.
- Avoid built-in installation, such as a book case or rack, unless proper ventilation is provided.

### 5 AVOID EXTREMELY HOT LOCATIONS OR SUDDEN TEMPERATURE CHANGES

Do not place the unit over or near any kind of heater or regulator, in direct sunlight, inside a closed vehicle, etc..

Do not move the unit suddenly between areas of extreme temperature variation. If the unit is suddenly moved from a cold place to a warm place, moisture may condense in the unit and on the tape.

### 6 TO AVOID PERSONAL INJURY

- Do not place unsecured equipment on a sloping surface.
- Do not place this unit on any support that is not firm, level, and adequately strong. The unit could fall causing serious injury to a child or adult and damage to the unit.
- An appliance and cart combination should be moved with care. Quick stops, excessive force, and uneven surfaces may cause the appliance and cart combination to overturn.
- Carefully follow all operating instructions and use the manufacturer's recommended accessories when operating this unit or connecting it to any other equipment.



## OUTDOOR ANTENNA INSTALLATION

### 1 SAFE ANTENNA AND CABLE CONNECTION

If an outside antenna or cable system is connected to the equipment, be sure the antenna or cable system is grounded so as to provide some protection against built up static charges and voltage surges.

Section 810 of the National Electrical Code, ANSI/NFPA 70 (In Canada, part 1 of the Canadian Electrical Code) provides information with respect to proper grounding of the mast and supporting structure, grounding of the lead-in wire to an antenna discharge unit, size of grounding conductors, location of antenna discharge unit, connection to grounding electrodes and requirements for the grounding electrode.

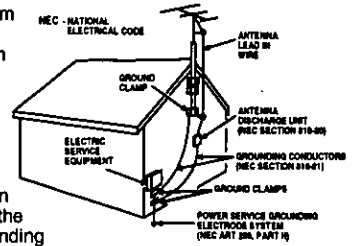

### 2 KEEP ANTENNA CLEAR OF HIGH VOLTAGE POWER LINES OR CIRCUITS

An outside antenna system should be located well away from power lines, electric light or power circuits and where it will never come into contact with these power sources if it should happen to fall. When installing an outside antenna, extreme care should be taken to avoid touching power lines, circuits or other power sources as this could be fatal. Because of the hazards involved, antenna installation should be left to a professional.

## USING THE VIDEO UNIT

If the unit has been in storage or moved to a new location, refer first to the INSTALLATION section of these safeguards.

### 1 KEEP THIS VIDEO UNIT AWAY FROM WATER OR MOISTURE OF ANY KIND.

**2 IF EQUIPMENT IS EXPOSED TO RAIN, MOISTURE, OR STRONG IMPACT,** unplug the unit and have it inspected by a qualified service technician before use.

### 3 DURING AN ELECTRICAL STORM

During a lightning storm, whether indoors or outdoors, or before leaving the unit unused for extended periods of time, disconnect all equipment from the power source as well as the antenna and cable system.

### 4 WHEN THE UNIT IS PLUGGED IN

- Never expose the unit to rain or water. **DO NOT OPERATE** if liquid has been spilled into the unit. Immediately unplug the unit, and have it inspected by a service technician. Fire and shock hazards can result from electrical shorts caused by liquid contact inside.
- Never drop or push any object through openings in the unit. Some internal parts carry hazardous voltages and contact can cause electric shock or fire hazard.
- Avoid placing the unit directly above or below your TV set as this may cause electrical interference. Keep all magnets away from electronic equipment.

### 5 USING ACCESSORIES

Use only accessories recommended by the manufacturer to avoid risk of fire, shock, or other hazards.

### 6 CLEANING THE UNIT

Unplug the unit. Then, use a clean, dry, chemically untreated cloth to gently remove dust or debris. **DO NOT USE** cleaning fluids, aerosols, or forced air that could over-spray, or seep into the unit and cause electrical shock. Any substance such as wax, adhesive tape, etc. may mar the cabinet surface. Exposure to greasy, humid, or dusty areas may adversely affect internal parts.

## SERVICE

### 1 DO NOT SERVICE THIS PRODUCT YOURSELF

If, after carefully following the detailed operating instructions, this Video product does not operate properly, do not attempt to open or remove covers, or make any adjustments not described in the manual. Unplug the unit and contact a qualified service technician.

### 2 IF REPLACEMENT PARTS ARE REQUIRED

Make sure the service technician uses only parts specified by the manufacturer, or those having the same safety characteristics as the original parts. The use of unauthorized substitutes may result in fire, electric shock, or other hazards.

### 3 HAVE THE SERVICE TECHNICIAN PERFORM A SAFETY CHECK

After any service or repairs to the unit, request the service technician to conduct a thorough safety check as described in the manufacturer's service literature to insure that the video unit is in safe operating condition.

# Unpacking Your VCR • Product Features

## Unpacking Your VCR

The accessories below are provided to help you use or set up your VCR.

### Accessories

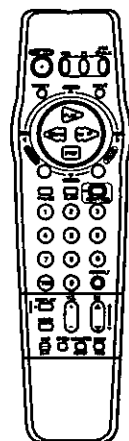

Remote Control  
VSQS1559

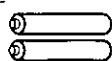

2 "AA"  
Batteries



RF Coaxial  
Cable  
VJAS0183

To order accessories,  
call toll free 1-800-211-PANA (7262).

## Loading the Batteries

- 1 Press in and up on the latch with your thumb nail and lift off the lid.

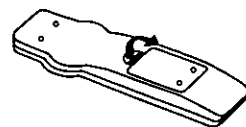

- 2 Install two batteries as indicated inside the Battery Compartment.

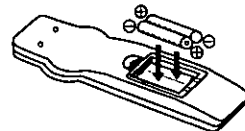

- 3 Fit the lid's hinge piece into the indent on the case, and snap the lid into place.

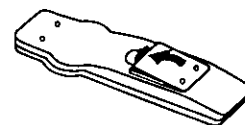

### Battery replacement caution

- Do not mix old and new batteries.
- Do not mix alkaline with manganese batteries.

## Product Features

All Channel Auto Set/ 181-CH TV/ CABLE Tuner .....	12 ~ 14
Auto Daylight Saving Time .....	5
Auto Features for a Quality Picture .....	16
Auto Operation Functions (Auto Playback, Rewind, Tape Eject, Power off) .....	23
Auto Repeat Function .....	23
Digital Auto Picture .....	16
Easy-to-Read English/ Spanish/ French On-Screen Displays .....	12 ~ 14, 18, 19
MTS Broadcast System (Multi-channel Television Sound-Stereo, SAP, Mono) .....	26
Multi Brand TV/ Cable Box/ DSS Remote Control .....	28, 29
One Minute Skip .....	23
One Month, 8 Program Timer Recording .....	18, 19
One Touch Recording (OTR) .....	17
Program Director Remote Control .....	18, 19
Special Effects Playback .....	16
Special VCR Features (Channel Caption, Time Stamp, Blue Back ON/OFF, VCR Lock, Warning Beeper) .....	20 ~ 22
Timer Recording Using VCR Buttons .....	19
VHS Hi-Fi Stereo System .....	27
VHS Index Search System (Direct Access Search, Program Index Search, Index Scan Search) .....	24, 25
Zero Search .....	23

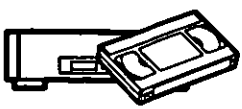

# VCR and Cassette Information

## Erase Protection (Record Tab)

Cassettes have a record tab to ensure that recordings are not accidentally erased.

To prevent accidental erasure, break off the tab with a screwdriver.



To record again, cover the hole with cellophane tape.



## Maximum Record/Playback Time

Only use tapes with the **VHS** mark in this unit.

Tape Speed Setting	Type of Video Cassette		
	T60	T120	T160
SP (Standard Play)	1 Hour	2 Hours	2 Hours 40 Minutes
LP (Long Play)	2 Hours	4 Hours	5 Hours 20 Minutes
SLP (Super Long Play)	3 Hours	6 Hours	8 Hours

## Head Cleaning

Your VCR will not normally require head cleaning, however the heads may become clogged when playing an old or damaged tape.

### Video Heads Sensor System

If head cleaning becomes necessary, the VCR will display the screen at right while playing back a recorded signal. To exit this screen, push PLAY on the remote control or VCR.

VIDEO HEADS MAY  
NEED CLEANING  
PLEASE INSERT HEAD  
CLEANING CASSETTE  
OR REFER TO MANUAL

END:PLAY KEY

- Use "dry" type head cleaning cassette\* only.
- Be sure to follow the cleaning tape instructions carefully. Excessive use of a cleaning cassette can shorten head life.
- If using a head cleaning cassette does not solve the problem, contact your nearest Factory Service Center or authorized Service Center. (See page 32.)

\* Cleaning cassette part No. NV-TCL30PT is recommended.

## Reset all VCR Memory Functions

Use when moving the VCR to a new location, or if a mistake was made in the One Time VCR Setup section.

- Make sure a tape is not inserted in the VCR.

- 1) Turn VCR Power on.
- 2) Press and hold both PLAY and CHANNEL ▲ on the VCR for more than 5 seconds.
  - The power will shut off.
- 3) Perform the One Time VCR Setup section on page 12.

## D.S.T. (Daylight Saving Time)

Your VCR can be set to automatically adjust the clock for Daylight Saving Time. (Page 13.)

### Spring (First Sunday in April)

When set to DST:ON, the VCR will automatically set the clock ahead one hour.

### Autumn (Last Sunday in October)

When set to DST:ON, the VCR will automatically set the clock back one hour.

- If your area does not observe Daylight Saving Time, select DST:OFF.
- Keep these time changes in mind when programming the VCR for timer recordings.

## Specifications

<b>Power Source:</b>	120V AC, 60 Hz
<b>Power Consumption:</b>	Approx. 23 watts (Power on) Approx. 4.1 watts (Power off)
<b>Video Signal:</b>	EIA Standard NTSC color
<b>Video Recording System:</b>	4 rotary heads helical scanning system
<b>Audio Track:</b>	1 track (Normal) 2 channel (Hi-Fi Audio Sound)
<b>Tuner:</b>	VHF 2-13, UHF 14-69
<b>Broadcast Channels:</b>	Midband A through I (14-22) Superband J through W (23-36) Hyperband AA-EEE (37-64)
<b>CABLE Channels:</b>	Lowband A-5-A-1 (95-99) Special CABLE channel 5A (01) Ultraband 65-94, 100-125
<b>Operating Temperature:</b>	41°F-104°F (5°C-40°C)
<b>Operating Humidity:</b>	10%-75%
<b>Weight:</b>	7.5 lbs. (3.4 kg)
<b>Dimensions:</b>	14-15/16" (W) x 3-2/3" (H) x 12-3/16" (D) 380 (W) x 93 (H) x 310 (D) mm

Note: Designs and specifications are subject to change without notice.



# Basic Connection

## ANTENNA

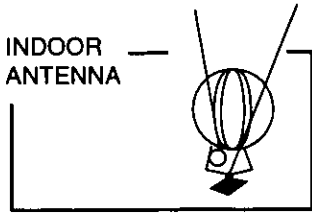

or

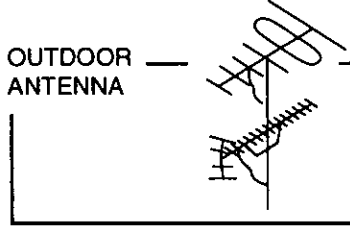

or

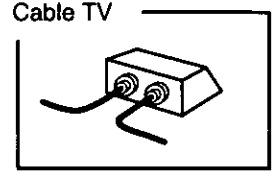

**1** Disconnect the antenna or cable from your TV and connect it to the VCR (IN FROM ANT.)

VCR

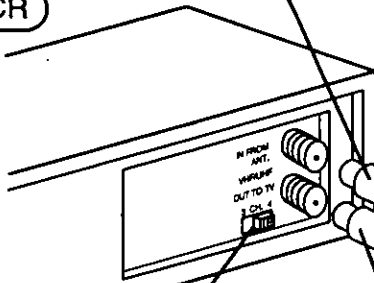

Antenna Cable

TV

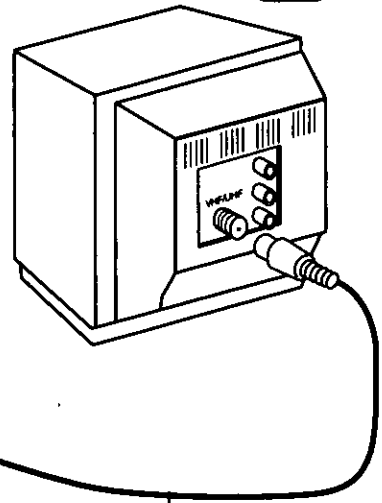

**3** Set the Output Channel of your VCR to channel 3 or 4 (whichever is not being transmitted on by a Local TV broadcast).

RF Coaxial Cable (VCR-TV Connection Cable) (supplied)

**2** Connect the VCR to your TV with the RF Coaxial Cable (OUT TO TV).

### WARNING

When using "Nut type" RF coaxial cables, tighten with fingers only. Overtightening may damage terminals.

## Between Antenna and VCR

### Case 1: Twin Lead Cable Only

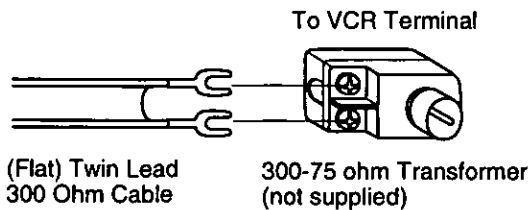

### Case 2: Twin Lead & Coaxial Cables

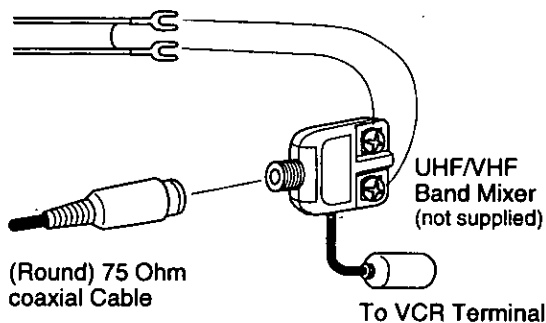

### Case 3: Two Twin Lead Cables

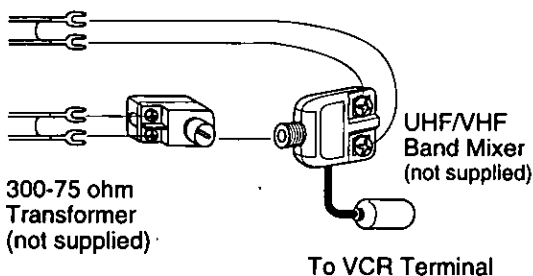

- If your TV has both post and plug-type VHF terminals, the post connection is recommended to minimize signal loss.

## Between VCR and TV

### Case 1: Screw & Plug Type Terminal

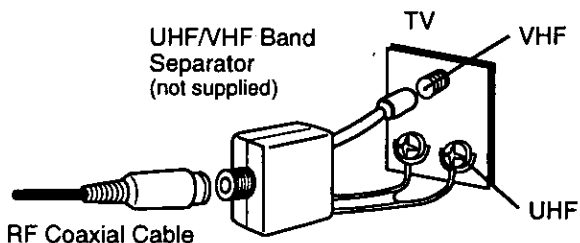

### Case 2: Screw Type Terminal

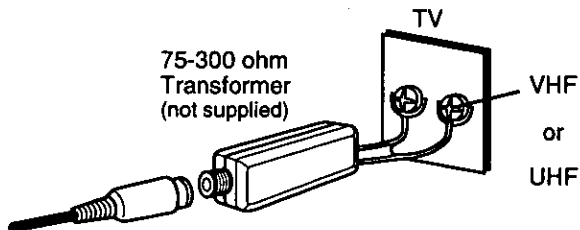

### Case 3: Double Screw Type Terminal

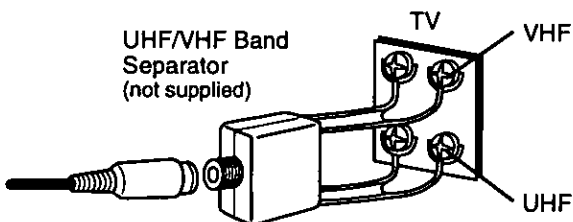

### Case 4: Complex TV Terminal

TERMINALS ON BACK OF TV SET

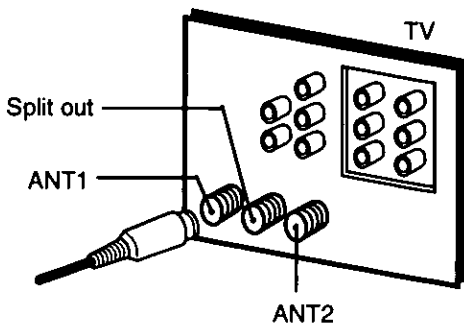

- Connect to one of the ANT terminals and select the same antenna number on the TV.



# Other Connections

## CABLE Connections

All connections on these pages are made with 75 Ohm coaxial cables.

### Without a Converter/Descrambler Box

You can:

- 1) Use your VCR Remote Control to select channels.
- 2) Program one or more unscrambled channels for unattended recording.

You cannot:

record or view scrambled channels with this connection.

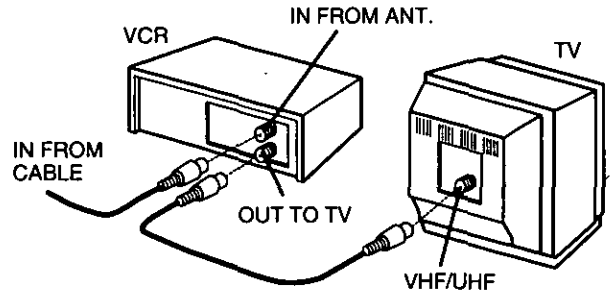

### With a (CABLE to VCR) Converter/Descrambler Box

You can:

- 1) Record and view any channel including scrambled channels; channel selection must be made at the Cable TV Converter Box.
- 2) Program one channel for unattended recording.

You cannot:

select channels from VCR or TV.

watch one station while recording another.

place channels in memory (pg.12) other than the Cable box output channel.

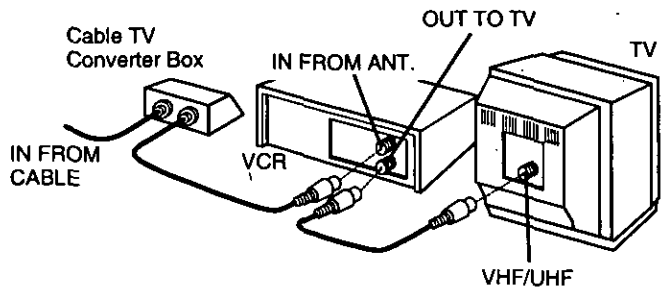

### With a (VCR to TV) Converter/Descrambler Box

You can:

- 1) Use your VCR Remote Control to select channels.
- 2) Program unattended recordings of more than one unscrambled channel.

You cannot:

record scrambled channels with this connection.

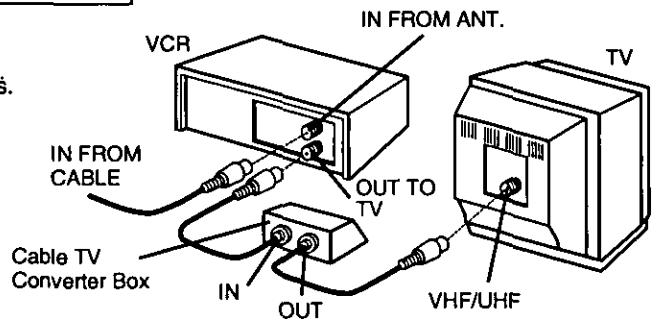

### With Two Converter/Descrambler Boxes

If you want to record and view a combination of scrambled and unscrambled channels, you will need additional equipment. This connection requires two converter boxes, an A/B switch, and a 2-way splitter as shown here.

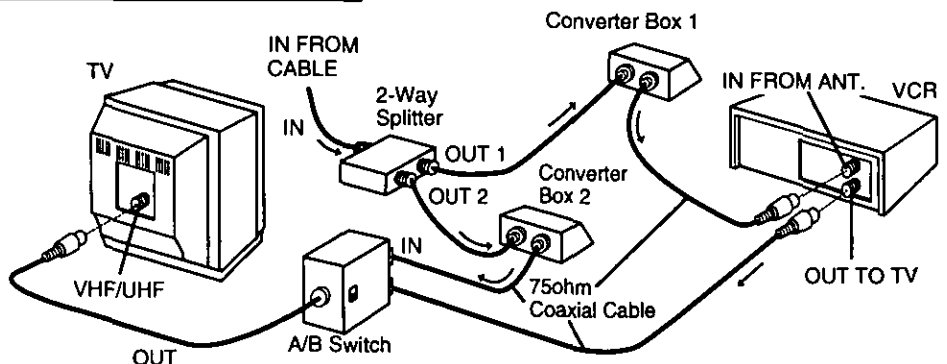



### With a DSS Receiver

You can:

- 1) Record and view any channel including scrambled channels; channel selection must be made at the DSS Receiver.
- 2) Program one channel for unattended recording.

NOTE: The DSS receiver must be turned off to view programs from a cable box or antenna. See the DSS manual for details.

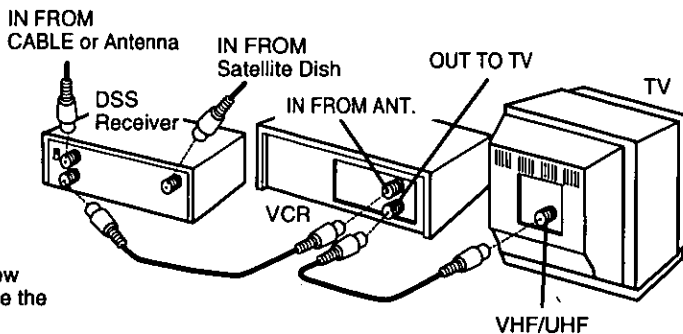

\*\*DSS<sup>®</sup> is a registered trademark of DIRECTV, INC., a unit of GM Hughes Electronics.

### Audio/Video Connections

If your TV has AUDIO IN and VIDEO IN terminals, you can connect your VCR to them to receive a higher quality picture and sound. If your TV is not stereo, you can connect a stereo amplifier to the VCR to enjoy stereo sound.

### Audio/Video Connections

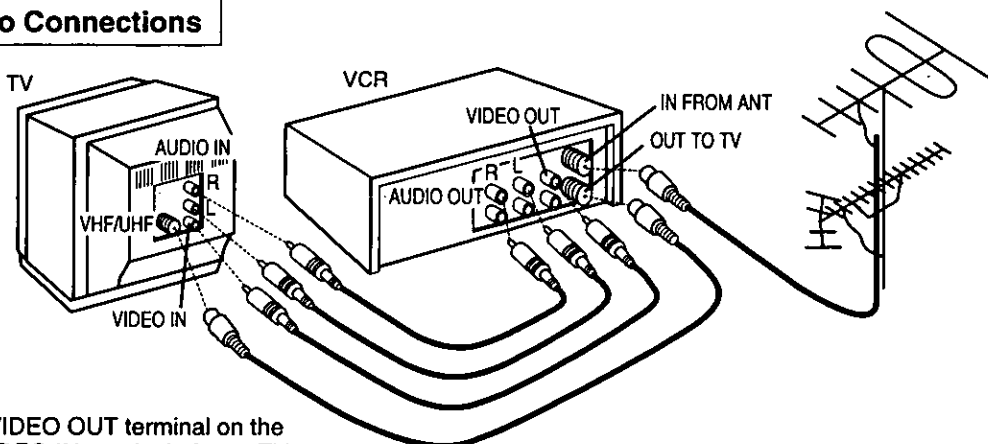

- 1 Connect the VIDEO OUT terminal on the VCR to the VIDEO IN terminal of your TV.
- 2 Connect the "L" and "R" AUDIO OUT terminals on the VCR to the "L" and "R" AUDIO IN terminals of your TV.
- 3 Set the VIDEO/TV selector of your TV (Monitor/Receiver) to "VIDEO."

NOTE: To use your TV as a VCR monitor, set the VIDEO/TV selector on the TV (Monitor/Receiver) to "VIDEO." Use the L Audio In jack for proper sound reproduction when connecting to a monaural TV.

### Stereo Amplifier Connections

When you connect your VCR to a Stereo Component System, you can view the picture from the VCR while enjoying stereo from your audio system.

Connect the "L" and "R" AUDIO OUT terminals on the VCR to the "L" and "R" AUDIO IN terminals of your stereo.

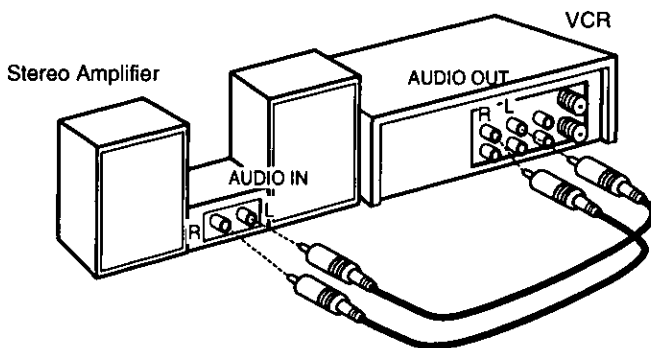

### Note to CABLE system installer:

This reminder is provided to call the CABLE system installer's attention to Article 820-40 of the NEC in USA (and to the Canadian Electrical Code in Canada) that provides guidelines for proper grounding and, in particular, specifies that the cable ground shall be connected to the grounding system of the building, as close to the point of cable entry as practical.

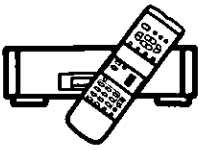

# Location of Controls

## Remote Control Buttons

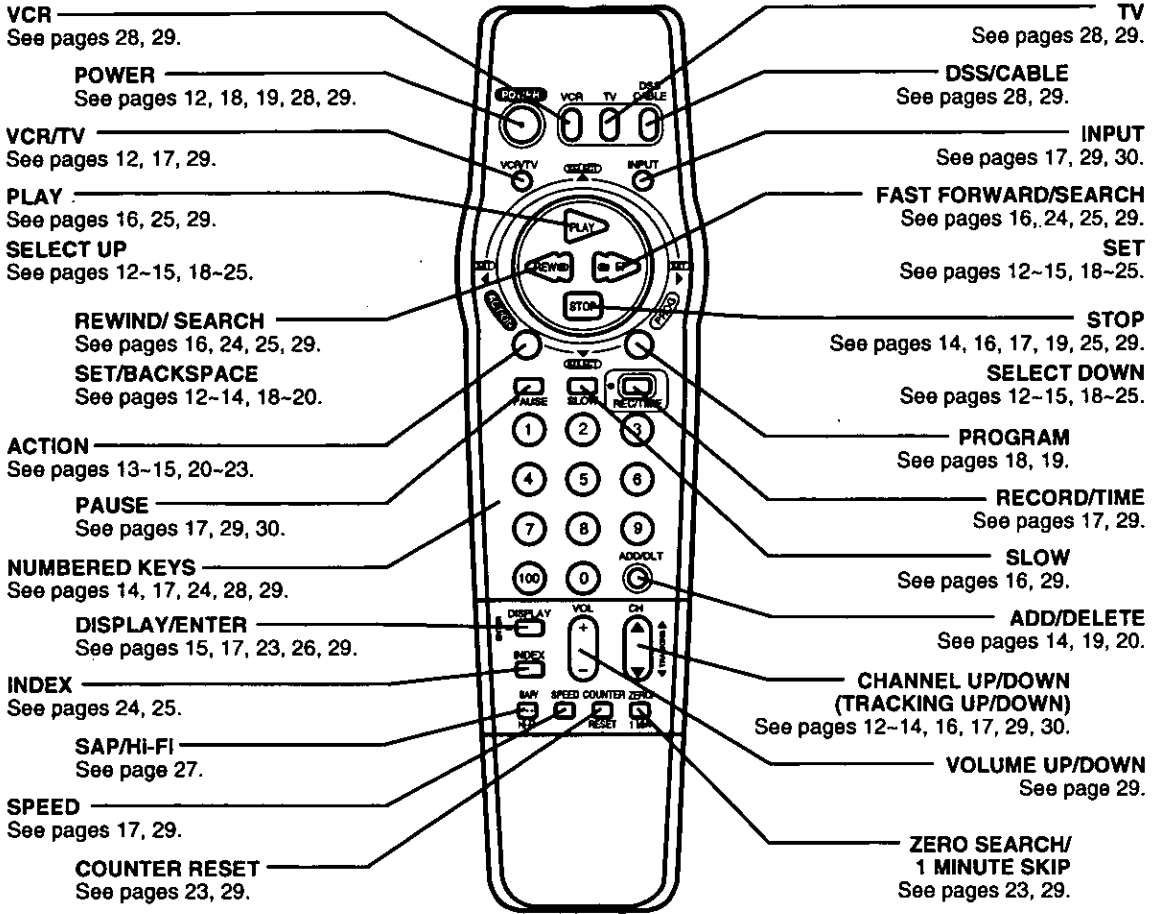

## Front View of the VCR

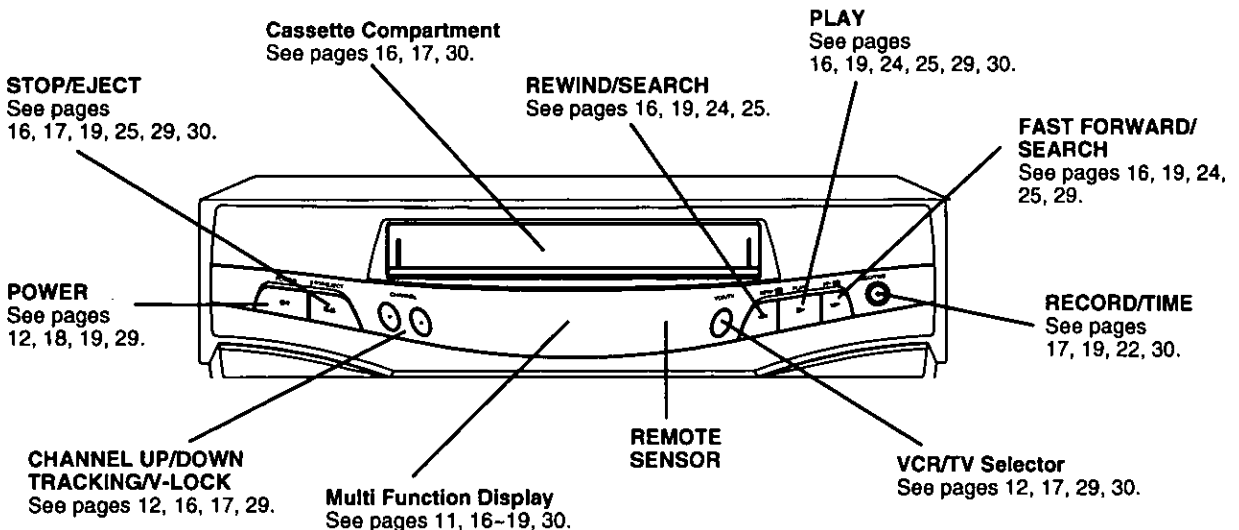

**Multi Function Display**

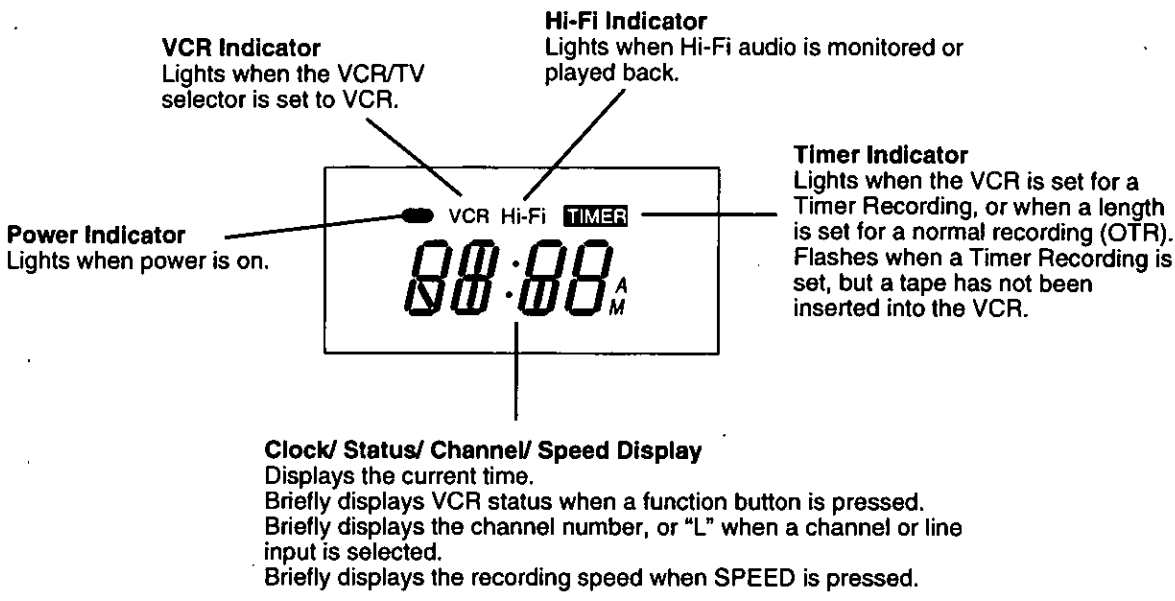

**Rear View of the VCR**

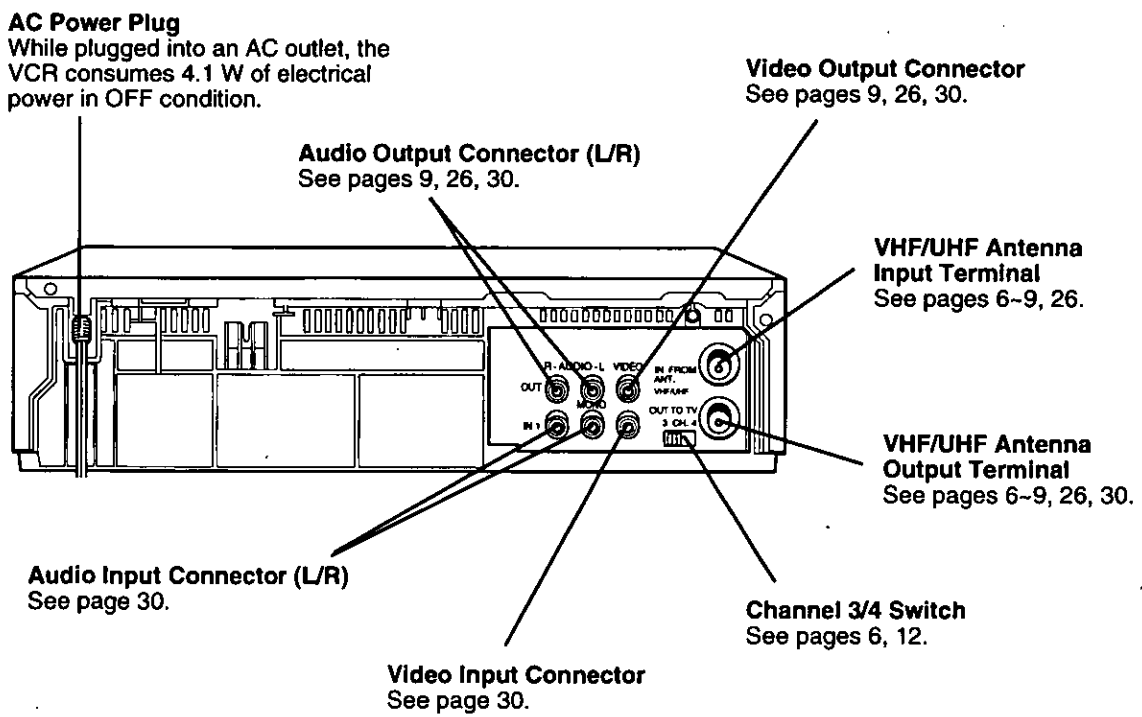



# One Time VCR Setup

**\*Important:** If the remote control POWER, ACTION, PROG, CH▲▼, INDEX, or ADD/DLT button does not work when pressed, press the VCR button on the remote and try the button again.

When the VCR is turned on for the first time, it automatically enters the setup mode.

Setup includes the following:

- Choose the language for on-screen menus and messages.
- Tell the VCR how your equipment is hookup (pages 6-9) so the VCR can correctly place channels into memory.
- Get the VCR ready for clock set.

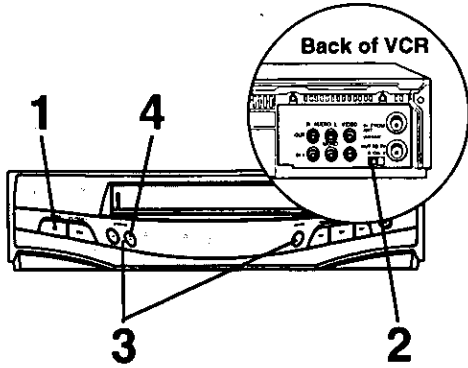

## To Set the Language, Channels, and Auto Clock

**1** Turn the TV and VCR on.\*

**2** Tune your TV to the VCR output channel (the same one you set on the back of the VCR: CH3 or CH4).

- If you used audio/video jack connection, tune the TV to its video input.

**3** Press CH ▲ for English on-screen displays.

Or, press CH ▼ for Spanish on-screen displays.

Or, press VCR/TV for French on-screen displays.

- You can also set the language using the buttons on the VCR.
- If wrong language is set, see the "Reset all VCR Memory Functions" section on page 5.
- The VCR should be connected to an antenna or cable box (page 6-9).

**SELECT LANGUAGE**  
 PUSH VCR CH ▲: ENGLISH  
 OPRIMIR VCR CH ▼: ESPAÑOL  
 APP. VCR/TV : FRANÇAIS

**4** Press CH ▲ to start Channel Auto Set and Clock Auto Set.

- The following messages appear: "CH AUTO SET PROCEEDING" "AUTO CLOCK SET PROCEEDING".

**CHANNEL/CLOCK AUTO SET**  
 CONNECT ANTENNA CABLE AND IF YOU USE A CABLE BOX, TUNE IT TO YOUR LOCAL PBS CH THEN...  
 PLEASE PUSH CH UP KEY

**Case 1**

1/ 4/2000 TUE 12:00PM  
 DST:ON  
 SETTING : CH 02  
 AUTO CLOCK SET  
 COMPLETED  
 END : PUSH CH UP KEY

**Case 2**

AUTO CLOCK SET  
 IS INCOMPLETE  
 PUSH ACTION TO SET CLOCK

- If you are using the CABLE/DSS BOX ► VCR ► TV connection method, only the cable box output channel will be placed in memory.

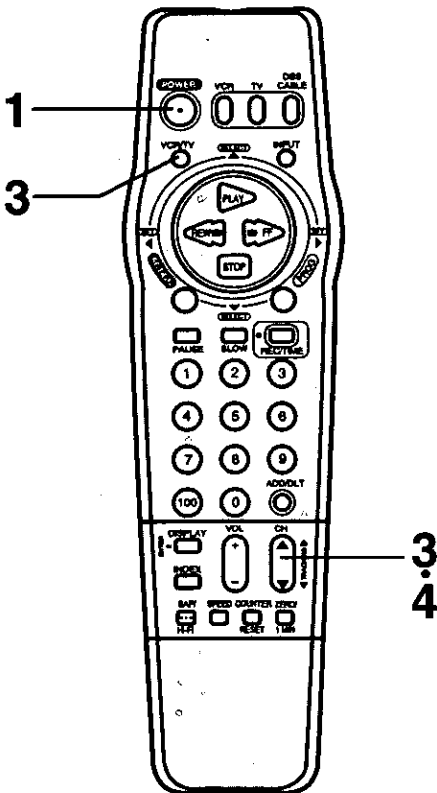

### Using ▲▼◀▶ keys

Whenever a menu or program screen is displayed, the PLAY, STOP, REWIND, and FF buttons on the remote control function as ▲▼◀▶ only. For play, stop, rewind, and fast forward functions, use the buttons on the VCR.



### Case 1

If the displayed time is correct, press CH ▲ to exit.

- This concludes one time VCR setup.
- See important note at the bottom of this page.

**If the displayed time and DST. are not correct...**

If you happen to live close to two time zones, the VCR have recognized the PBS channel (setting channel) in the wrong time zone. Please do the following to correct the situation.

- Make a note of the SETTING:CH number shown on-screen and press CH ▲ to exit.
- Delete the setting channel from the VCR channel memory. (See "To Add or Delete a Channel" section on page 14.)
- Press ACTION to display the menu.
- Press ▲▼ to select "SET CLOCK," and then press ► to display the "SET CLOCK" screen.
- Press ▲▼ to select "AUTO CLOCK SET," and then press ► to display the "CLOCK AUTO SET" screen.
- Press CH ▲ to start Clock Auto Set.
  - If you use a cable box and have multiple PBS stations, tune the cable box to a different PBS station and try auto clock set using the menu.

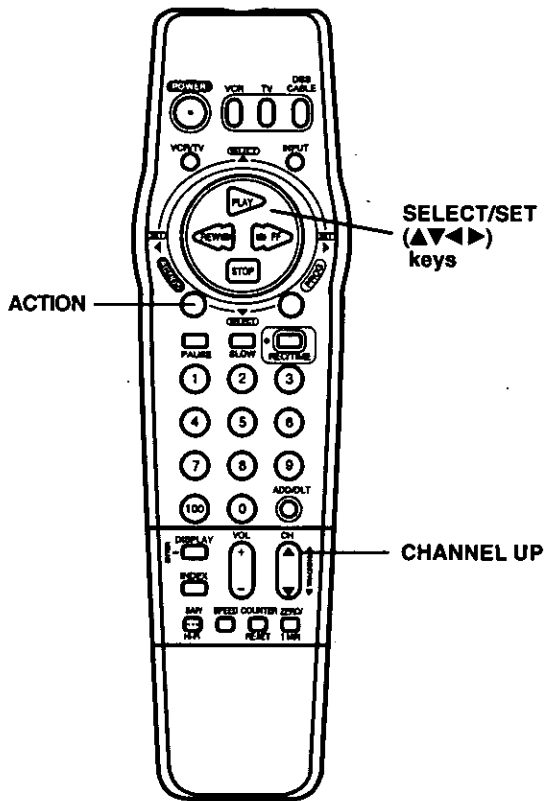

### Case 2

If the screen above appears, auto clock set is not available in your area. Please set the clock manually as described below.

- Press ACTION to display the "SET CLOCK" screen.

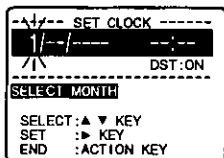

- Press ▲▼ and ◀▶ to select and set the month, date, year, time, and DST. (Daylight Saving Time).

- See page 5 for more on DST.

**To Make Corrections,**

repeatedly press ◀▶ to move the cursor to the incorrect entry and make the correction.

- Press ACTION twice to start the clock and exit this mode.



### IMPORTANT NOTE FOR AUTO CLOCK SET

- Auto clock set will be performed when the VCR is turned off the first time each day. If you use a cable box and you want auto clock set to be performed, the cable box must be left on and tuned to the PBS channel before the VCR power is turned off.
- If you use a DSS receiver, it must be turned off for auto clock set.
- If you use Audio/Video Jack connection between the VCR and Cable Box or DSS receiver, you must also connect the RF coaxial cable in order to use the auto clock set and channel auto set features.

# One Time VCR Setup

**\*Important:** If the remote control POWER, ACTION, PROG, CH▲▼, INDEX, or ADD/DLT button does not work when pressed, press the VCR button on the remote and try the button again.

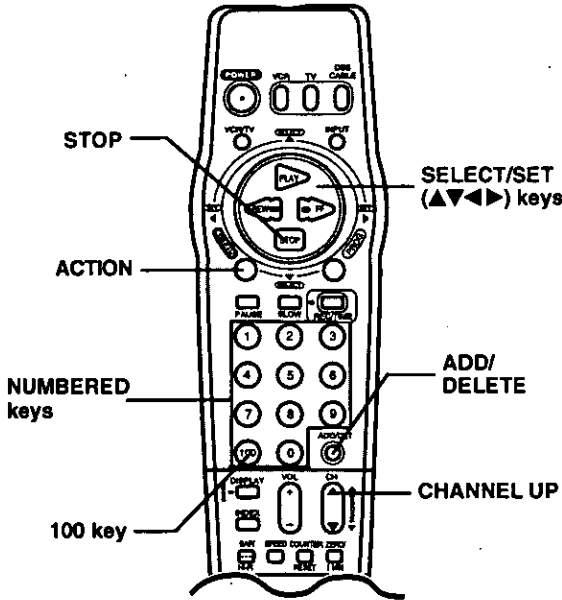

## To Replace Channels in Memory

In case you have cable installed, etc.

- 1 Press ACTION\* to display the menu.
- 2 Press ▲▼ to select "SET UP CHANNEL," and then press ▶ to display the "SET UP CHANNEL" screen.
- 3 Press ▲▼ to select "ANTENNA," and then press ▶ to set your antenna system (TV or CABLE).
- 4 Press ▲▼ to select "AUTO SET," and then press ▶ to display the "CHANNEL CLOCK AUTO SET" screen.
  - If you use a cable box, turn it on and set it to the PBS channel in your time zone.
  - To exit this mode, press ACTION twice.
- 5 Press CH ▲ to start Channel Auto Set.
  - Clock Auto Set will be performed when channels are replaced in memory. To cancel, press STOP when "AUTO CLOCK SET PROCEEDING" appears on-screen.

```

----- MENU -----
SET UP VCR
SET UP FEATURE
SET CLOCK
SET UP CHANNEL
ID/OMA/LANGUE: ENGLISH
SELECT: ▲ ▼ KEY
SET : ▶ KEY
END : ACTION KEY
    
```

```

----- SET UP CHANNEL -----
ANTENNA : CABLE
AUTO SET
CHANNEL CAPTION

SELECT: ▲ ▼ KEY
SET : ▶ KEY
END : ACTION KEY
    
```

```

CHANNEL/CLOCK AUTO SET
CONNECT ANTENNA CABLE
AND IF YOU USE A CABLE
BOX, TUNE IT TO YOUR
LOCAL PBS CH THEN...

PLEASE PUSH CH UP KEY
    
```

## To Change On-Screen Display Language

- 1 Press ACTION to display the menu.
- 2 Press ▲▼ to select the language.
  - English: LANGUAGE
  - Spanish: IDIOMA
  - French: LANGUE
- 3 Press ▶ repeatedly to change the language.

```

----- MENU -----
SET UP VCR
SET UP FEATURE
SET CLOCK
SET UP CHANNEL
ID/OMA/LANGUE: ENGLISH
SELECT: ▲ ▼ KEY
SET : ▶ KEY
END : ACTION KEY
    
```

```

----- MENU -----
SET UP VCR
SET UP FEATURE
SET CLOCK
SET UP CHANNEL
ID/OMA/LANGUE: ESP
SELECT: ▲ ▼ KEY
SET : ▶ KEY
END : ACTION KEY

----- MENU -----
PREPARAR VCR
FIJACION DE FUNCION
FIJAR RELOJ
FIJAR CANAL
LANGUE/LANGUAGE: ESP
ELEGIR: ▲ ▼
FIJAR : ▶
TERMINAR: ACTION

----- MENU -----
REGLAGE MAGNETOSCOPE
REGLAGE MAGNETO SUPPLEM
REGLAGE HORLOGE
REGLAGE CANAL
LANGUE/IDIOMA: FRANÇAIS
SEL : ▲ ▼
REGLER: ▶
FIN : ACTION
    
```

- 4 Press ACTION to exit this mode.

## To Set or Reset the Clock

In case the clock is wrong, or a power failure occurred.

- 1 Press ACTION to display the menu.
- 2 Press ▲▼ to select "SET CLOCK," and then press ▶ to display the "SET CLOCK" screen.
- 3 Press ▲▼ to select "MANUAL," and then press ▶ to display the SET CLOCK screen.
- 4 Press ▲▼ and ◀▶ to select and set the date, time, and DST. (Daylight Saving Time).
- 5 Press ACTION twice to start the clock and exit this mode.

```

----- MENU -----
SET UP VCR
SET UP FEATURE
SET CLOCK
SET UP CHANNEL
ID/OMA/LANGUE: ENGLISH
SELECT: ▲ ▼ KEY
SET : ▶ KEY
END : ACTION KEY
    
```

```

----- SET CLOCK -----
AUTO CLOCK SET
MANUAL

SELECT: ▲ ▼ KEY
SET : ▶ KEY
END : ACTION KEY
    
```

```

----- SET CLOCK -----
17 4/2000 TUE 12:00PM
DST: ON

SELECT MODE

SELECT: ▲ ▼ KEY
SET : ▶ KEY
END : ACTION KEY
    
```

- For Auto Clock Set, select "AUTO CLOCK SET," and then press CH ▲ in step 3.

## To Add or Delete a Channel

- 1 Select a channel using the NUMBERED keys to add or CH ▲/▼ to delete.
- 2 Press ADD/DLT to add or delete the channel.
  - To select a channel once it's deleted, use the NUMBERED keys on the remote control.

```

CHANNEL 08 ADDED

CHANNEL 08 DELETED
    
```

## When Using the 100 key

When selecting CABLE channels 100 to 125 with the NUMBERED keys, first press the 100 key and then enter the remaining two digits. For example, to select channel 125: Press NUMBERED keys 100, then 2, then 5.



- This VCR will accurately maintain its calendar up to Dec. 31, 2096, 11:59PM.
- Normal TV or Cable channels are automatically selected and placed in memory depending on how your VCR is hooked up.



# On-Screen Displays (OSD)

## Function & Channel Display

When a function button is pressed, e.g. PLAY, or you change channels, a 4 second display appears first in large and then small characters. (Some Station names may also appear if Channel Caption is set. See page 20.)

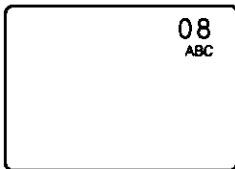

## Menu Screen

1 Press ACTION to display the menu.

2 Press ▲▼ and ► to make your selection.

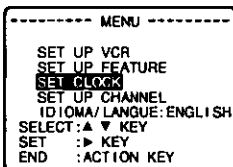

- To get the most from each feature, please read the Operating Manual before attempting any operation.

## VCR Status & Clock Display

Press DISPLAY to display or remove the overlay shown below.

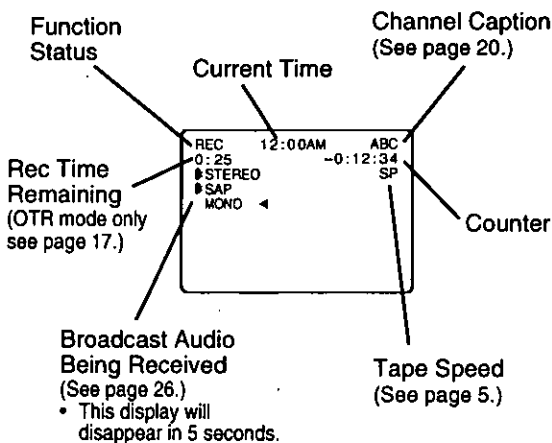

## Blank Tape/ No Video Signal Indication

Whenever a blank section of a tape comes up in Play mode, or when the selected channel has no broadcast signal with the Blue Back ON/OFF Feature (page 21) set to ON, the TV screen will turn solid blue.

## Warning and Instruction Displays

These displays will alert you of a missed operation or provide further instructions.

If no active channels are found for CHANNEL MEMORY... (See page 12.)

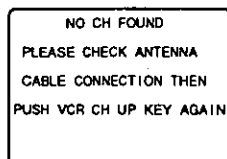

If you attempt to set or review a Timer Recording and the Clock is not set... (See page 18.)

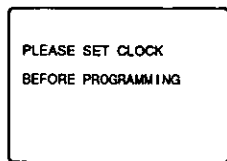

After a Timer Program has been set... (See page 18.)

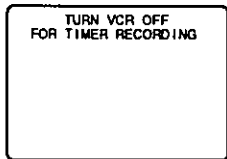

If you press REC on the remote control or VCR, and a cassette is inserted with no record tab... (See page 17.)

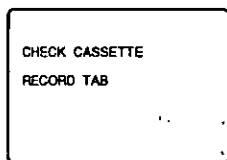

If you press PLAY, FF, REW, or REC on the remote control or VCR without a cassette inserted... (See pages 16, 17.)

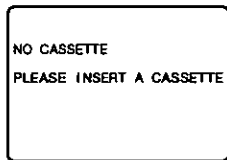

If you press POWER or STOP during a Timer Recording... (visible in VCR mode only) (See page 19.)

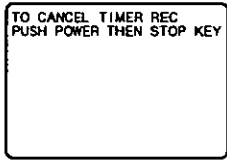

If head cleaning becomes necessary while playing back a tape... (See page 5.)

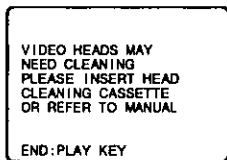

If you press a function button other than STOP/EJECT or POWER while the VCR is in VCR Lock mode... (See page 22.)

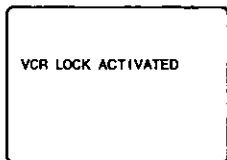

If you press POWER, ACTION, or PROG on the remote while in TV or CABLE/DSS mode... (See pages 28, 29.)

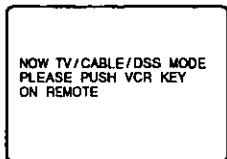

Getting Started



# Playback a Tape

**\*Important:** If the remote control POWER, ACTION, PROG, CH▲▼, INDEX, or ADD/HLT button does not work when pressed, press the VCR button on the remote and try the button again.

## ✓ Check list before you begin.

- All connections are made. (See pages 6-9.)
- TV and VCR are plugged in.
- TV is turned on and set to the VCR channel (CH 3 or 4).

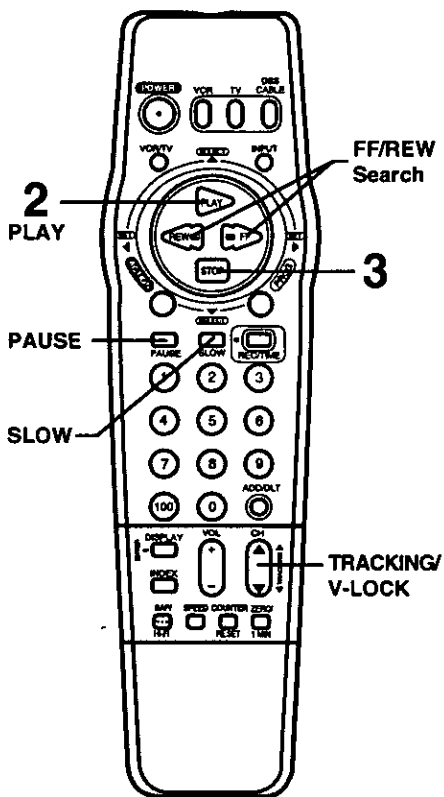
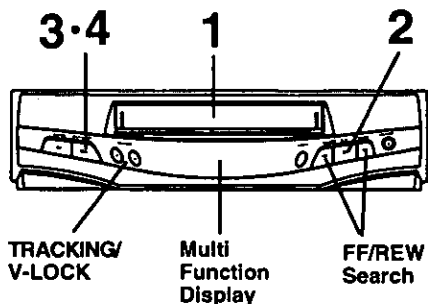

## 1 Insert a cassette.

- VCR power comes on automatically.
- "VCR" lights in the Multi Function Display.

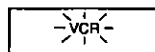

## 2 Press PLAY on the remote or VCR to start playback.

- Playback begins automatically if cassette has no record tab.

## 3 Press STOP on the remote or VCR to stop playback.

- To rewind the tape, press REW.

## 4 Press STOP/EJECT on the VCR to eject the cassette.

- You may eject a cassette with power on or off.

## To Find a Particular Scene During Playback

Press REW or FF during playback to search for a scene.

- Search speed for SP mode tapes is 7 times and SLP mode tapes is 21 times the normal speed.
- Some noise bars will appear during search.

## Special Effects During Playback

These features work best in SP or SLP mode. The sound will be muted.

### Slow Motion Playback

Press SLOW to start slow motion playback during playback. Press PLAY or SLOW to release.

### Still (Freeze) Frame Picture

Press PAUSE to freeze and release the picture.

- To reduce picture noise, first press SLOW. Then, use CH (TRACKING) ▲▼\* to clear up the picture. Now, press PAUSE.

### Frame by Frame Advance

In Still mode, hold down SLOW to advance the still picture one frame at a time. Press PAUSE to release.

## Features for a Quality Picture

### Digital Auto Picture

This feature automatically controls the video output signal for less noise depending on the tape condition.

### Digital Auto Tracking

This feature continuously analyzes the signal and adjusts for optimum picture quality.

### Manual Tracking Control (to reduce picture noise)

Use during Playback and Slow Motion mode to reduce picture noise. Press CH (TRACKING) ▲▼ during playback until the picture clears up. To return to Auto Tracking mode, press POWER off and then on again.

### V-Lock Control (to reduce picture jitter)

In Still mode, CH (TRACKING) ▲▼ operate as a V-Lock control. Press ▲▼ until the picture is stabilized.

## Caution:

Please inspect your cassette tapes and remove any loose or peeling labels to prevent them from becoming jammed in your unit.

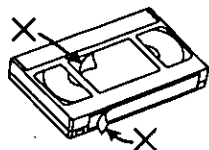

- After the VCR is in Still or Slow mode for 3 minutes, it will switch to the Stop mode automatically to protect the tape and the video head.



# Record On a Tape

## Check list before you begin.

- All connections are made. (See pages 6-9.)
- VCR is plugged in.
- TV is turned on and set to the VCR channel (CH 3 or 4).

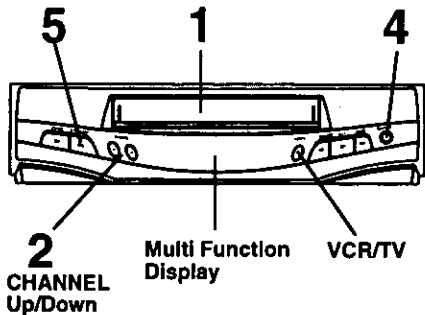

## 1 Insert a cassette with record tab.

- VCR power comes on automatically.

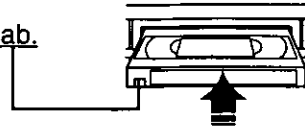

## 2 Press CH ▲▼ or NUMBERED keys to select a channel.

- Or, press CHANNEL ▲▼ on the VCR.
- Holding down CH ▲▼ will increase the channel search speed.
- To record from an outside source, press CH ▲▼ or INPUT to select "LINE" (see page 30).

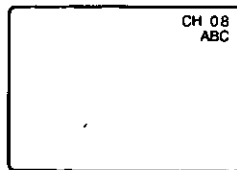

## 3 Press SPEED to change the recording speed.

- SP = Standard Play ,
- LP = Long Play
- SLP = Super Long Play (See page 5.)

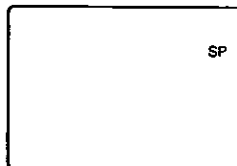

## 4 Press REC/TIME on the remote control or VCR to start recording.

- To edit out unwanted portions, press PAUSE to pause the recording in progress. To release, press PAUSE again. (After the VCR has been in Pause mode for 5 minutes, it will stop automatically to protect the tape and video head.)

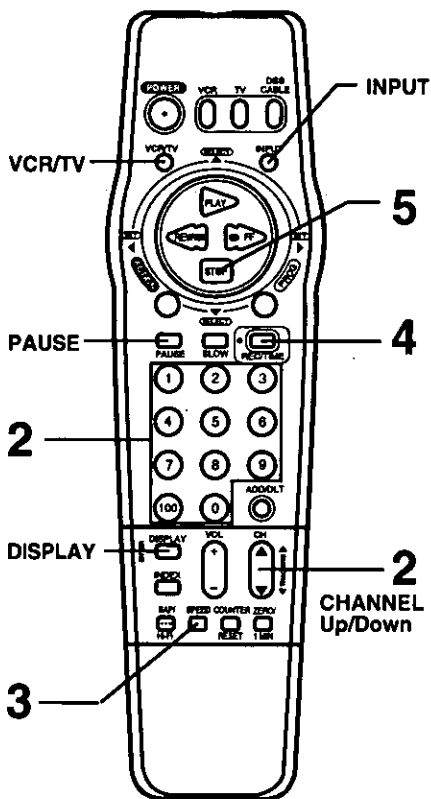

### One Touch Timer Recording (OTR)

The VCR starts recording and turns itself off at a preset time.

In step 4, **press REC/TIME** repeatedly to set the length of the recording. Each press will change the stop time as shown.

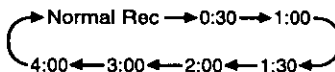

- "TIMER" lights in the Multi Function Display.
- The remaining recording time can be displayed by pressing DISPLAY in OTR mode.

## 5 Press STOP to stop recording.

- Or, press STOP/EJECT on the VCR.

## Record One Program While Watching Another

- 1 Press VCR/TV while recording is in progress to turn off the VCR indicator in the Multi Function Display.
- 2 Use the TV channel controls to select a program. The VCR will continue to record your program while you watch any channel you choose.
  - To switch back and forth between the recording and viewing channel, press VCR/TV.

## Selecting Channels at the VCR

- 1 Turn your TV and VCR on.
  - VCR Indicator lights on the Multi Function Display. If indicator doesn't light, press VCR/TV to turn it on.
- 2 Use CH ▲▼ on the remote control or VCR to select channels.
  - To switch back to TV channel selection, press VCR/TV to turn VCR indicator off, or simply turn the VCR power off.



# Timer Recording

**\*Important:** If the remote control POWER, ACTION, PROG, CH▲/▼, INDEX, or ADD/HLT button does not work when pressed, press the VCR button on the remote and try the button again.

You can set up the VCR to record a one time, daily, or weekly program while you are away or otherwise occupied. Up to 8 programs can be stored in memory.

## Check list before you begin.

- All connections are made. (See pages 6-9.)
- TV and VCR are plugged in and turned on.
- VCR/TV selector is set to "VCR."
- Clock is set to correct time.
- Record tab in place. (See page 5.)

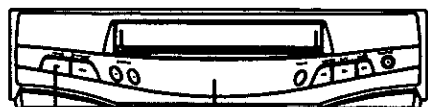

6 Multi Function Display

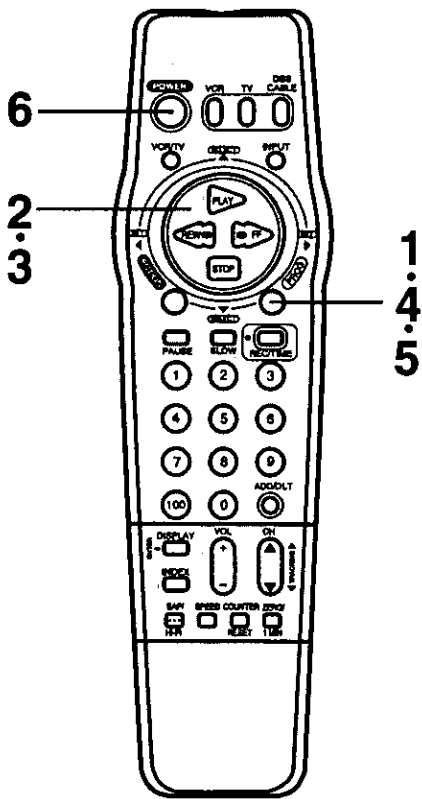

## 1 Press PROG\* to display the program screen.

- If a program is already in memory, press ▲▼ and ► to select an unused program number.



## 2 Press ▲▼ and ► to select and set one of the following as the DATE:

- 1-31 = One time recording
- DAILY = Same time MON-FRI
- WEEKLY (SUN-SAT) = Same time once a week

### Example

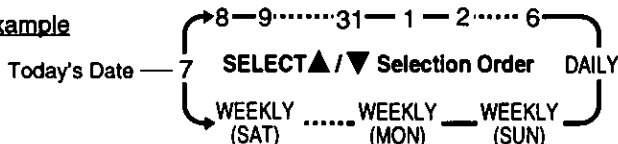

## 3 Press ▲▼ and ◀▶ to select and set each of the remaining items at right.

- Remaining Items to be set:**
- START time
  - STOP time
  - CH(annel) number, or LINE for outside source recording
  - Category (N/A [not applicable], SPORTS, MOVIE, COMEDY, MUSIC, DRAMA)
  - Speed (SP, LP, SLP)

### To Make Corrections

Repeatedly press ► to move the cursor to the right, or ◀ to move to the left to the incorrect entry and make the correction.

## 4 Press PROG to end the program.

- This screen appears for confirmation.

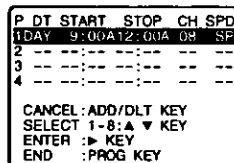

### To Enter More Programs

Press ▲▼ and ► to select and set a blank program number, and then repeat steps 3 and 4.

## 5 Press PROG to exit this mode.

## 6 Press POWER off to set the timer.

- When recording programs via a cable box, make sure the cable box is left ON and tuned to the desired channel.



Multi Function Display

## NOTES

- A cassette with no record tab is ejected and "TIMER" flashes when the power is turned off to set the timer.
- If the start times of two programs overlap, the lower numbered program will have priority.
- If the start time for a timer recording comes up during a normal recording or One Touch Recording (page 17), the timer recording will not be performed.
- If there is a power interruption of more than one minute, the recording will not be performed or continue.

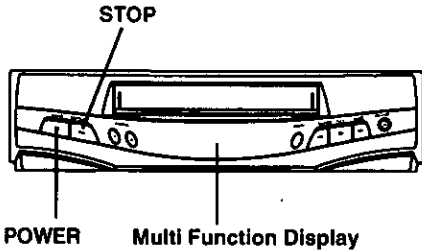

### Cancel a Timer Recording: (Recording is in progress)

Press POWER and then STOP within 10 seconds to cancel the timer recording.

- The TIMER indicator goes out in the Multi Function Display.

### Replace Program Contents: (Recording is not in progress)

- 1 Press PROG to display all currently set programs.
- 2 Press ▲▼ and ► to select and set a program number.  
(See page 18.)
- 3 Press ▲▼ and ◀▶ to select and set replacement timer information.
- 4 Press PROG twice to exit this mode.

P	DT	START	STOP	CH	SPD
1	---	---	---	---	---
2	8	10:00P	12:00P	125	SP
3	10	8:00P	9:00P	10	SP
4	SU	9:00P	10:00P	L	LP

SELECT 1-8: ▲ ▼ KEY  
ENTER : ► KEY  
END : PROG KEY

DATE	START	STOP	CH
8 SAT	10:00P	12:00P	125
TODAY			
CATEGORY: SPORTS			ABC
			SP

SELECT: ▲ ▼ KEY  
SET : ◀ ▶ KEY  
END : PROG KEY

### Review or Clear Program Contents: (Recording is not in progress)

- 1 Press PROG to display all currently set programs.
- 2 Press ▲▼ to select "TIMER PROGRAM," and then press ► to display all currently set programs.
- 3 Press ▲▼ to select a program number.
- 4 Press ADD/DLT if you want to clear the program.
- 5 Press PROG to exit this mode.

P	DT	START	STOP	CH	SPD
1	DAY	9:00A	12:00A	08	SP
2	8	10:00P	12:00P	125	SP
3	10	8:00P	9:00P	10	SP
4	SU	9:00P	10:00P	L	LP

CANCEL: ADD/DLT KEY  
SELECT 1-8: ▲ ▼ KEY  
ENTER : ► KEY  
END : PROG KEY

P	DT	START	STOP	CH	SPD
1	---	---	---	---	---
2	8	10:00P	12:00P	125	SP
3	10	8:00P	9:00P	10	SP
4	SU	9:00P	10:00P	L	LP

SELECT 1-8: ▲ ▼ KEY  
ENTER : ► KEY  
END : PROG KEY

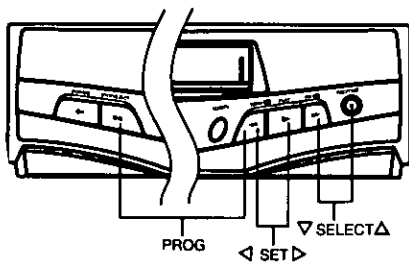
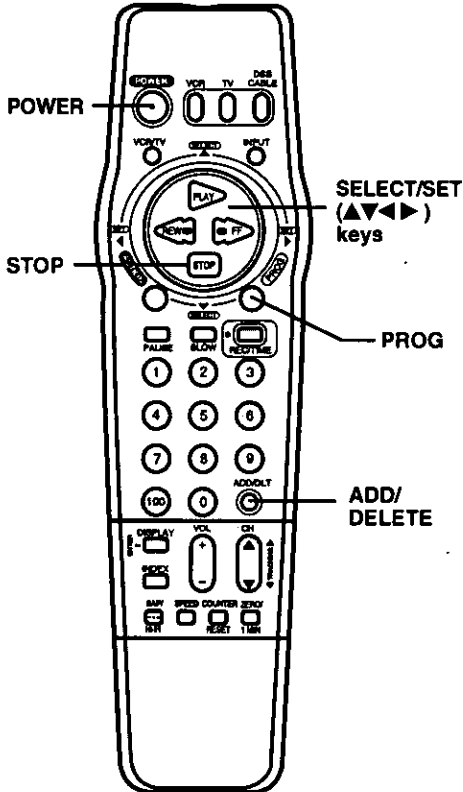

### Timer Recording Using VCR Buttons

(Make sure a cassette tape is not inserted in the VCR.)

- 1 Hold down STOP/EJECT and press REW to enter the Program mode.
- 2 Press FF or REC/TIME repeatedly or hold down to make selections.
- 3 Press PLAY to set the item and move on.
  - To make corrections, repeatedly press PLAY to move the cursor to the right, or REW to move to the left to the incorrect entry and make the correction.
- 4 Press STOP/EJECT and REW together to display program contents after all items have been entered.
  - You cannot clear programs with the VCR buttons.
- 5 Hold down STOP/EJECT and press REW, (release REW first, and then release STOP/EJECT) to exit this mode.
- 6 Insert a cassette with record tab and press POWER off to set the timer.



# Special VCR Features

**\*Important:** If the remote control POWER, ACTION, PROG, CH▲▼, INDEX, or ADD/DLT button does not work when pressed, press the VCR button on the remote and try the button again.

## Channel Caption

You can set channel names, i.e. ABC, CBS, so that when selected, the channel name and number appear on-screen for easy identification. You can go with preset names (up to 24), or manually create your own (up to 10).  
Note: You will need a list of channels received in your area and the channel numbers you receive them on.

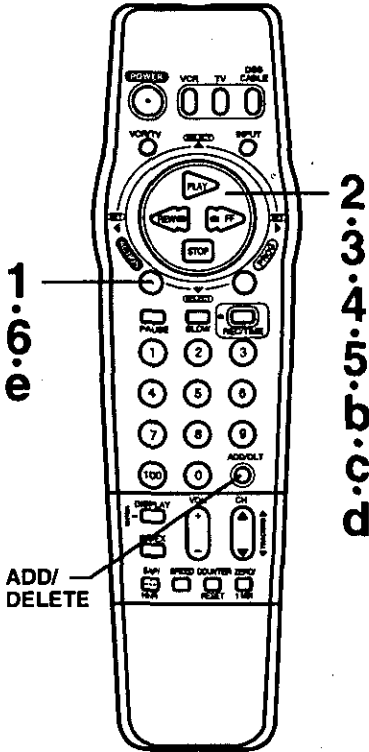

## Preset Caption

- 1 Press **ACTION**\* to display the menu.
- 2 Press **▲▼** to select "SET UP CHANNEL," and then press **▶** to display the "SET UP CHANNEL" screen.
- 3 Press **▲▼** to select "CHANNEL CAPTION," and then press **▶** to display the "CHANNEL CAPTION" screen.
- 4 Press **▲▼** to select "PRESET CAPTION," and then press **▶** to display the "PRESET CAPTION" screen.
  - You can set up to twenty-four channel captions. If you want to set a station name other than these, go to the "Manual Caption" section below.
- 5 Press **▶** to move the shaded area to right side. Then, press **▲▼** to change the memorized channel number to match the caption. Next, press **◀** to set the memorized channel number. Now, press **▲▼** to continue. Repeat step 5 until the Caption List is complete.

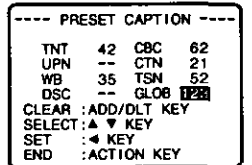
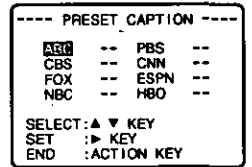
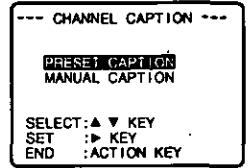
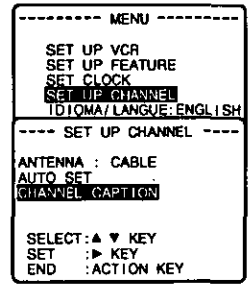

### To Make Corrections

Press **▲▼** and **▶** to select the memorized channel number. Then, press **▲▼** to change, or ADD/DLT to delete the channel number.

- 6 Press **ACTION** four times to exit this mode and return to the normal screen.

## Manual Caption

**a** Follow steps 1~3 in the above section.

**b** In step 4, press **▲▼** to select "MANUAL CAPTION," and then press **▶** to display the "MANUAL CAPTION" screen.

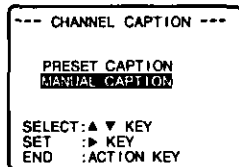

**c** Press **▲▼** to select "CH NUMBER," and then press **▶** to move the shaded area to right.

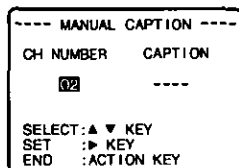

- Channels already set in the "Preset Caption" section and channels deleted from Channel Memory are not displayed.
- You can set a total of ten channel captions with up to four characters each.

**d** Press **▲▼** to select, and then press **▶** to enter each character of the caption.

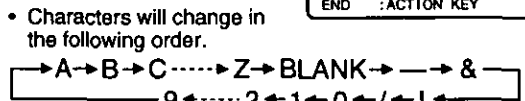
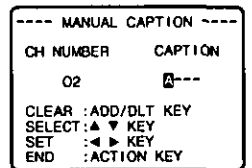

Now, press **◀** repeatedly to move the cursor back to CH NUMBER. Repeat steps "c" and "d" as desired.

To Make Corrections, repeatedly press **▶** to move the cursor to the right, or **◀** to move to the left to the incorrect entry and make the correction. To Clear the Caption, press ADD/DLT.

**e** Press **ACTION** four times to exit this mode and return to the normal screen.

- Check list before you begin.
- Clock is set to correct time.

## Time Stamp Feature

Whenever a recording is made, the VCR automatically writes the following program data on the tape: Date, Start time, Scheduled stop time (for Timer Rec. only), Channel No., Category (for Timer Rec. only). About 7 seconds after playback is started, this information will be displayed for 5 seconds.

**1** Press **ACTION** to display the menu.

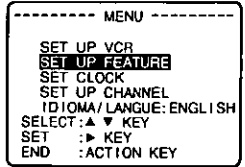

**2** Press **▲▼** to select "SET UP FEATURE," and then press **▶** to display the "SET UP FEATURE" screen.

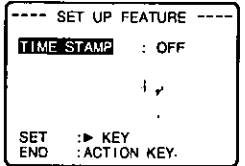

**3** Press **▶** to select "ON" or "OFF."

- When "OFF" is selected, the program data is written on the tape, but will not be displayed for the first 5 seconds of playback.

**4** Press **ACTION** twice to exit.

<Time Stamp Example>

Normal/

One Touch Recording

```

12/28/1998 MON
12:00PM
CH 08 ABC
  
```

Timer Recording

```

12/28/1998 MON
12:00PM - 1:00PM
CH 08 ABC SPORTS
  
```

When Clock is not set...

```

---/--/---
---:--:--
CH 08 ABC
  
```

- If the tape speed is changed immediately after recording begins, the display may be incorrect.

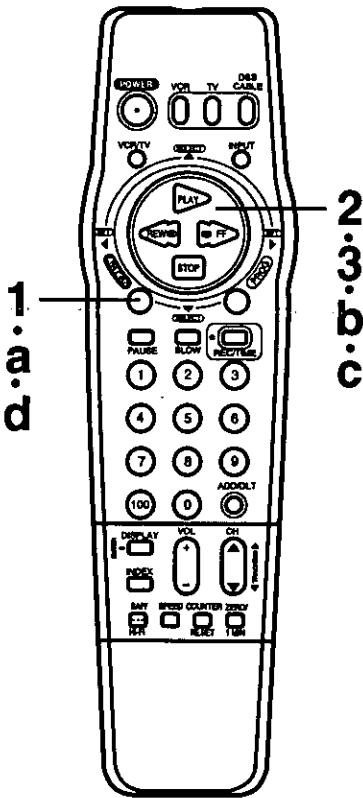

## Blue Back ON/OFF Feature

You may choose whether or not you want the VCR to display a solid blue back screen when the broadcast signal is very weak.

**a** Press **ACTION** to display the menu.

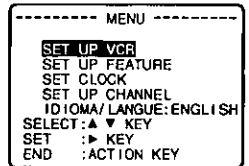

**b** Press **▲▼** to select "SET UP VCR," and then press **▶** to display the "SET UP VCR" screen.

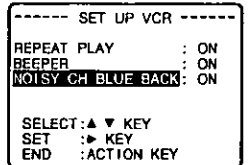

**c** Press **▲▼** to select "NOISY CH BLUE BACK," and then press **▶** to select "ON" or "OFF."

- When "ON" is selected, a solid blue screen appears whenever the signal is weak or nonexistent. When "OFF" is selected, the picture is displayed regardless of the signal condition.
- The picture can not always be seen clearly when "OFF" is selected.

**d** Press **ACTION** twice to exit.

**NOTE**

• When the VCR is connected to a Combination VCR which has a Blue Back feature, even if the VCR Blue Back is set to "OFF" on the VCR, the screen will go to blue back.

# Special VCR Features (continued)

**\*Important:** If the remote control POWER, ACTION, PROG, CH▲/▼, INDEX, or ADD/HLT button does not work when pressed, press the VCR button on the remote and try the button again.

## ✓ Check list before you begin.

- All connections are made. (See pages 6-9.)
- VCR is plugged in.
- TV is turned on and set to the VCR channel (CH 3 or 4).

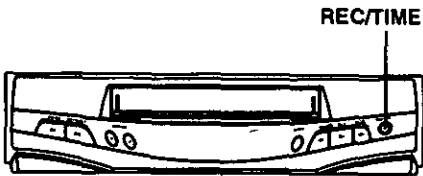

## VCR Lock Feature

When activated, this feature prohibits all operations except for timer recording and tape eject. This feature may be used to keep young children from operating the VCR.

**Hold down REC/TIME on the VCR without a cassette inserted for 7 seconds while in Stop mode.**

VCR LOCK ACTIVATED

**To Cancel the VCR Lock feature, with or without a cassette inserted, hold down REC/TIME on the VCR for 7 seconds again while in Stop mode.**

VCR LOCK OFF

- VCR Lock mode is cancelled automatically after about 24 hours as long as the clock is set.

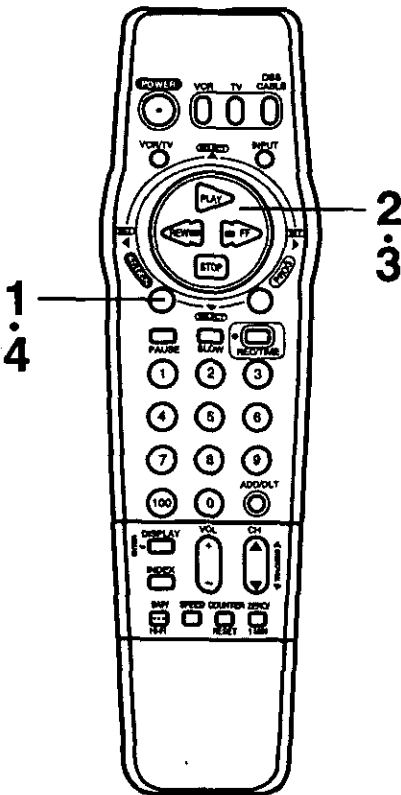

## Warning Beeper Feature

When you select BEEPER ON, a short warning will sound each time an invalid entry or incomplete operation is made.

**1 Press ACTION\* to display the menu.**

```

----- MENU -----
SET UP VCR
SET UP FEATURE
SET CLOCK
SET UP CHANNEL
ID IOMA/ LANGUAGE: ENGLISH
SELECT: ▲ ▼ KEY
SET : ► KEY
END : ACTION KEY
    
```

**2 Press ▲▼ to select "SET UP VCR," and then press ► to display the "SET UP VCR" screen.**

**3 Press ▲▼ to select "BEEPER," and then press ► to select "ON" or "OFF."**

```

----- SET UP VCR -----
REPEAT PLAY : ON
BEEPER : ON
NOTSY CH BLUE BACK: ON

SELECT: ▲ ▼ KEY
SET : ► KEY
END : ACTION KEY
    
```

**4 Press ACTION twice to exit this screen.**



# Tape Operation

Your VCR is equipped with several time saving features as well as convenient automatic functions making tape operation easier than ever.

## Repeat Play

The VCR will play your recording over and over.

**1** Press **ACTION** to display the menu.

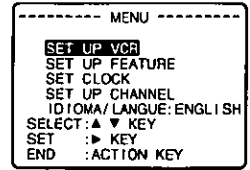

**2** Press **▲▼** to select "SET UP VCR," and then press **▶** to display the "SET UP VCR" screen.

**3** Press **▲▼** to select "REPEAT PLAY," and then press **▶** to select "ON" or "OFF."

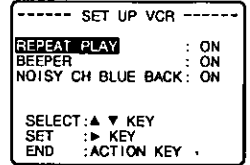

- When "ON" is selected, the VCR plays the tape to its end or until a blank portion of over 30 seconds is detected (erased portions are not considered blank). The tape is then rewound and played again and again until Repeat Play is turned off.

**4** Press **ACTION** twice to return to the normal screen.

## One Minute Skip

The VCR rapidly skips over one minute of tape.

**A** Press **ZERO/ 1 MIN** in Play mode.

- The VCR will go into FF search mode and skip over 60 seconds of recorded time. Normal playback will then resume.

## Zero Search

To quickly return to a specific tape location.

**a** Press **DISPLAY** to display the Time Counter overlay during playback.

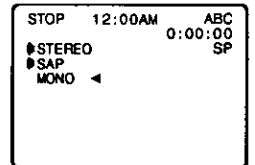

**b** Press **COUNTER RESET** to reset the Time Counter to "0:00:00" at the desired position.

**C** Continue playback, rewind, or fast forward.

**d** Press **ZERO/1MIN** in Stop mode when you want to return to "0:00:00."

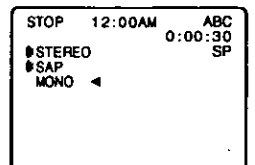

- The VCR will go into FF or REW mode and stop at the last point the Time Counter was set to 0:00:00.

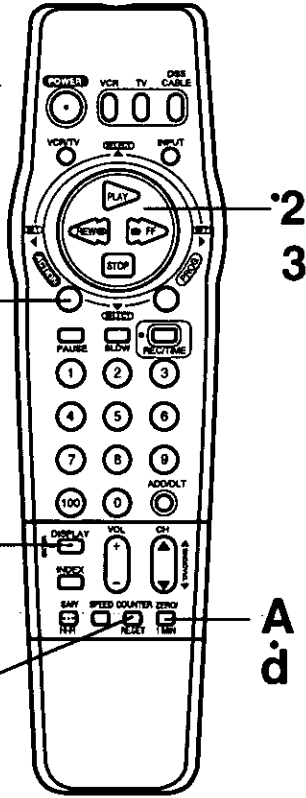

## Auto Operation Functions

### Auto Playback

When a tape is inserted, the power turns on (Auto). If the record tab\* is removed, playback begins (Auto).

### Auto Rewind

When a tape reaches its end during playback, fast forward or manual record, the VCR will rewind and go into Stop mode.

### Playback Auto Eject (Repeat Play is "OFF.")

When a tape without a record tab\* is played to its end, the VCR will rewind and then eject the tape.

### Memory Rewind Off

When the **POWER** button is pressed during rewind, the VCR will turn off after rewind is complete.

\* For record tab information, see page 5.

# Tape Operation (continued)

**\*Important:** If the remote control POWER, ACTION, PROG, CH▲▼, INDEX, or ADD/HLT button does not work when pressed, press the VCR button on the remote and try the button again.

## VHS Index Search System

Each time you start a recording, an invisible index mark is placed on the tape. When timer recordings are made, program index and program information (see "Time Stamp Feature" on page 21) are also included. You can then use these index marks to access or scan your recordings.

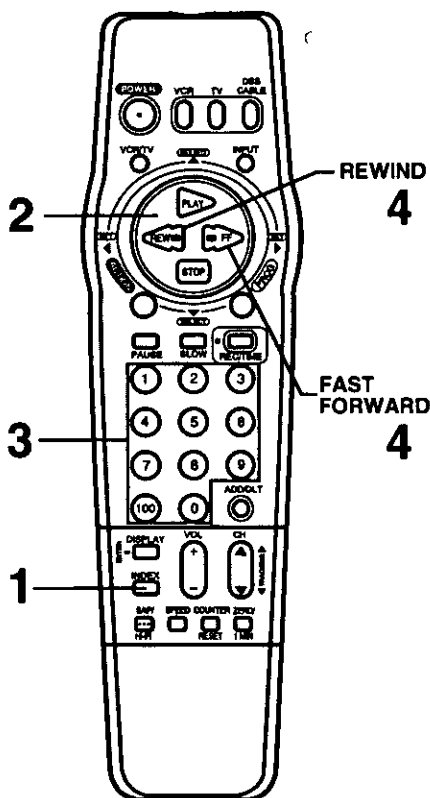
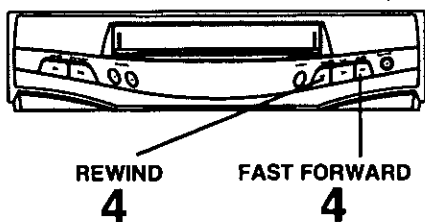

## Direct Access

### (For normal and/or timer recordings)

This feature allows you to go directly to the recording you want from anywhere on the tape by entering the appropriate index number.

**1** Press **INDEX\*** to display the "SELECT SEARCH MODE" screen.

- This screen appears only if there are timer recordings on the Program Index list. If this screen does not appear, go to step 3.

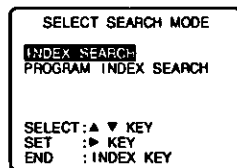

**2** Press **▲▼** to select "INDEX SEARCH," and then press **▶** to display the "INDEX" screen.

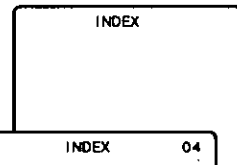

**3** Press a **NUMBERED** key to select the desired recording.

- To calculate the number, see below.



**4** Press **REW** or **FF** to start a reverse or forward search.

- When the designated location is reached, the VCR goes into Playback mode.

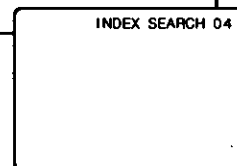

### To calculate the Index Number

Count forward or backward each recording starting point, including the recording you want to see, from wherever you are on the tape.

**Example 1:**

If you are watching recording 4 and you want to watch recording 2, count the start points to number 2. The total is 3. Enter 3 in step "3" and press REW.

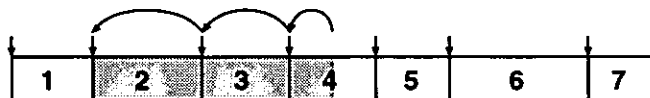

**Example 2:**

If you are watching recording 2 and you want to watch recording 6, count the start points to number 6. The total is 4. Enter 4 in step "3" and press FF.

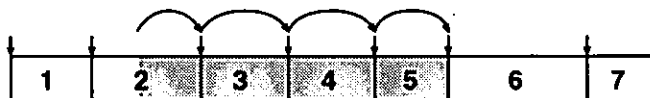

**NOTE:** ↓ indicates start points of each recording.



- Make each entry within 10 seconds, or the Index Search mode will be canceled.
- Index marks will be placed for Timer recordings as well.
- If the Direct Access index search is initiated extremely close to an index mark, the index mark may not be counted in the search.
- In the Program Index Search, this VCR can be memorized 8 programs in order of recording. If over 8 programs, the first program will be deleted and the new program will be listed.



**Important for Program Index Search:** Timer recordings must be recorded back to back in order for them to be placed on the Program Index list. If a timer recording is followed by a function, such as REW or PLAY, the data is lost.

## Program Index Search (For timer recordings only)

This feature allows you to choose a timer recorded program from a Program Index list and then start a search for that program. Once the tape is ejected or normal recording is started, all program index data are deleted.

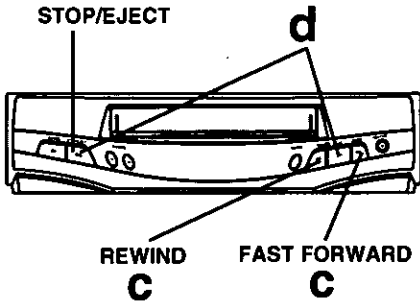

**1** Press **INDEX** to display the "SELECT SEARCH MODE" screen.

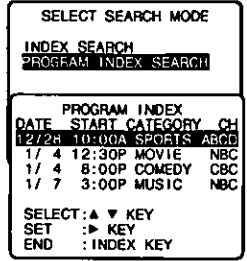

**2** Press **▲▼** to select "PROGRAM INDEX SEARCH," and then press **▶** to display the "PROGRAM INDEX" screen.

**3** Press **▲▼** to select the desired recorded program, and then press **▶** to start the forward or rewind search.

- When the designated program is reached, the VCR goes into Playback mode.

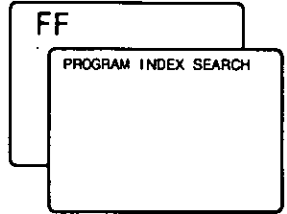

## Index Scan

(For normal and/or timer recordings)

This feature allows you to scan (forward or reverse) each recording for 10 seconds in Playback mode.

**a** Press **INDEX** to display the "SELECT SEARCH MODE" screen.

- This screen appears only if there are timer recordings on the Program Index list. If this screen does not appear, go to step c.

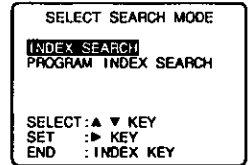

**b** Press **▲▼** to select "INDEX SEARCH," and then press **▶** to display the "INDEX" screen.

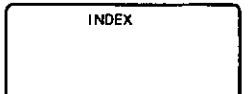

**c** Press **REW** or **FF** to begin the scan.

- As each index mark is reached, a short playback will be performed after which FF or REW resumes.

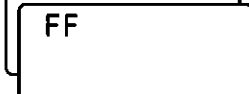

**d** Press **PLAY** to cancel the scan and begin playback.

- You may also press **STOP** to stop the tape.

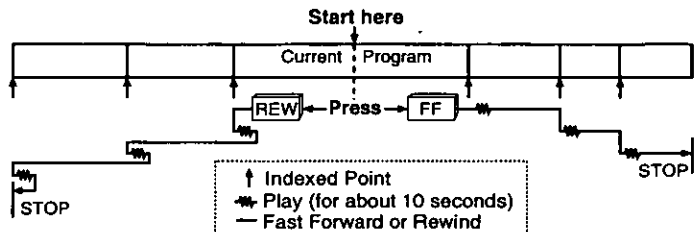
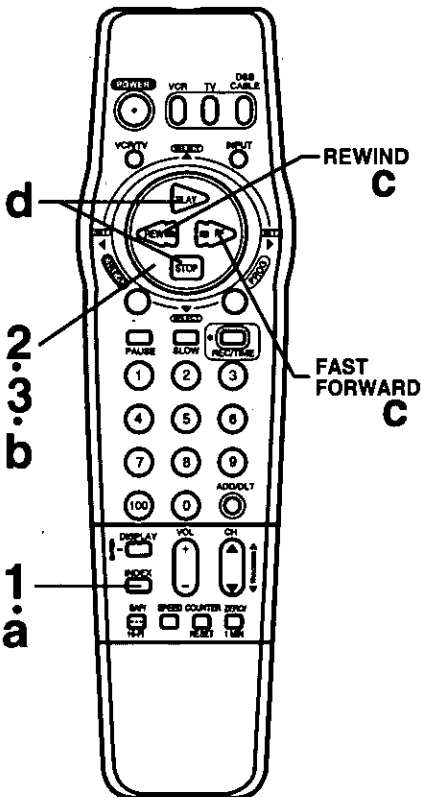

More You Can Do

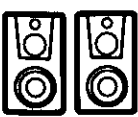

# MTS Broadcast/ VHS Hi-Fi Stereo System

**Check list before you begin.**

- The VCR is connected to a stereo TV, or a mono TV and an external stereo amp or receiver with speakers.
- The VCR and other components are plugged in and turned on.

## Connections to Make

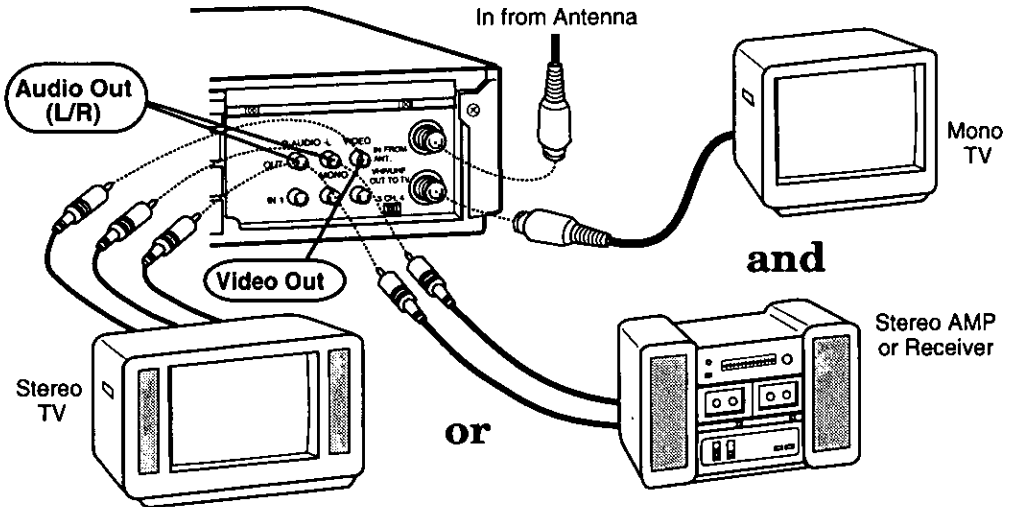

When recording, you may monitor in stereo, by connecting the VCR to either a stereo TV, or a mono sound TV with an external stereo amp and speakers.

## Receivable Broadcast Types

The following are possible audio broadcast types and on-screen displays.

The signal being received is indicated with an "R" mark while the selected audio mode is indicated with an arrow.

Press **DISPLAY** to display the broadcast signal currently being received.

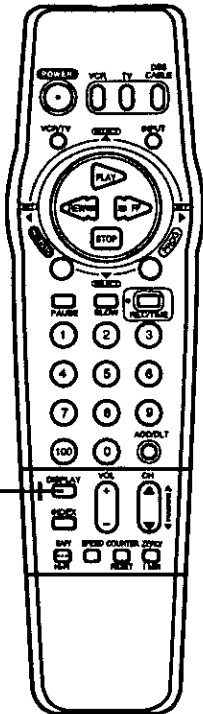

### MTS Stereo and SAP broadcast

Multi-channel Television Sound Stereo (main language) and Secondary Audio Program (sub language) broadcasts are being received simultaneously. Select STEREO or SAP audio mode.

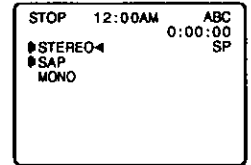

### MTS Stereo broadcast

Multi-channel Television Sound Stereo broadcast. Select STEREO audio mode.

- If a stereo broadcast is weak and the display flickers, you may want to select the MONO audio mode for better results.

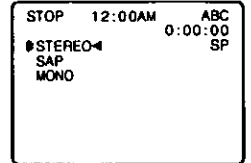

### SAP broadcast

Secondary Audio Program (sub language) broadcast. Select SAP audio mode for the sub language.

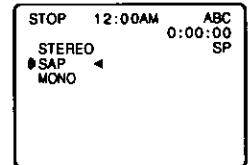

### MONO broadcast

Normal monaural sound broadcast.

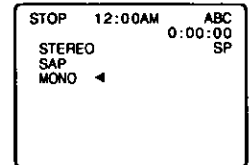

Equipped with **dbx** -TV Noise Reduction for true MTS reproduction. **dbx** -TV Noise Reduction is required for good stereo separation and audio fidelity. **dbx** is a registered trademark, and is licensed by **dbx** Technology Licensing.

### With the proper audio mode setting, your VCR can:

- 1) record and playback an MTS stereo broadcast (main language) in stereo Hi-Fi.
  - 2) record and playback a monaural broadcast (main language) or Secondary Audio Program (sub language) on the Hi-Fi tracks for better quality monaural sound.
  - 3) playback non Hi-Fi tapes in monaural.
- When recording, the selected broadcast sound is always recorded on the left and right Hi-Fi tracks as well as the normal monaural track. This means your tapes can be played back on Hi-Fi as well as non-Hi-Fi VCRs.

## Audio Mode for Recording

- 1 Press SAP/Hi-Fi repeatedly** (each press within 5 seconds) to select the desired audio mode (STEREO, SAP, or MONO).

- Please refer to the "Receivable Broadcast Types" section on page 26.

STEREO ◀  
SAP  
MONO

- The arrow indicates your selection.

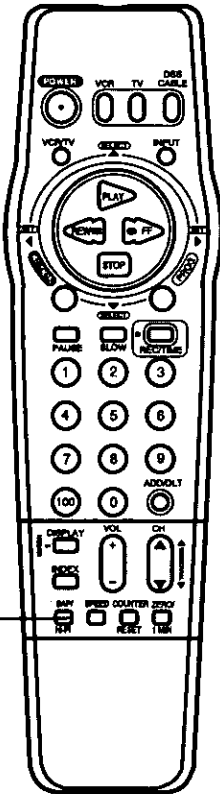

- 2 Do a recording.** See the "Record On a Tape" section on page 17.

## Audio Mode for Playback

- a Playback the tape.** See the "Playback a Tape" section on page 16.

- b Press SAP/Hi-Fi repeatedly** (each press within 5 seconds) to select the desired audio mode (HIFI or NORMAL).

- Select "HIFI" to listen to your stereo recordings with stereo sound, or "NORMAL" for monaural sound.

HIFI ◀  
NORMAL

- The arrow indicates your selection.

### NOTES

- When purchasing or renting prerecorded tapes, remember that only those recorded in Hi-Fi stereo will play back with true stereo sound. Standard stereo tapes will play back with monaural sound.
- In order to listen to Hi-Fi stereo playback, the VCR AUDIO (L/R) jacks must be connected to a stereo TV or an external stereo amp and speakers. (See page 26.)
- When adjusting the tracking during playback, the Hi-Fi audio sound may revert to normal audio sound. This is normal.
- There may be a difference in audio level between Hi-Fi and normal audio playback.



# Multi-Brand Control Feature

The Remote Control may be set up to control some of the functions on your TV or Cable Box.

## TV Brand Code Numbers

Panasonic .....	01, 02	Toshiba .....	09
Quasar .....	01, 02	Sanyo .....	10
RCA .....	03	Fisher .....	10
GE .....	03	JVC .....	11
Zenith .....	04	Hitachi .....	12
Magnavox .....	05	Mitsubishi .....	07, 13
Sylvania .....	05	Samsung .....	14
Sharp .....	06, 07	Gold Star .....	15, 16, 17
Sony .....	08		

## DSS Brand Code Numbers

Toshiba .....	103
Hitachi/ Hughes .....	104
Magnavox/ Uniden 1 .....	105
Magnavox/ Uniden 2 .....	106
Sony .....	107
RCA .....	108
Panasonic .....	109

## Cable Box Brand Code Numbers

Archer .....	01, 29, 44, 88, 91
Cableview .....	04, 30, 42, 44, 52, 63, 85, 88
Citizen .....	04, 30, 42, 44, 52, 63, 85, 88
Curtis .....	08, 09, 56, 61, 87, 90
Diamond .....	01, 29, 44, 88, 91
Drake .....	37, 67, 71
Eagle .....	13, 20, 22, 26, 40, 58, 62, 98
Eastern .....	28
GC Brand .....	04, 30, 42, 44, 52, 63, 85, 88
Gemini .....	04, 85
General Electric .....	57
General Instruments .....	
..... 01, 02, 03, 04, 34, 55, 83, 85, 91, 93, 95	
Hamlin .....	14, 15, 28, 41, 97, 100, 102
Hitachi .....	31, 79
Jerrold .....	
..... 01, 02, 03, 04, 34, 55, 83, 85, 91, 93, 95	
Macom .....	31, 79
Magnavox .....	25, 26
Matsushita .....	16, 17, 101
Movietime .....	29, 32, 38, 39, 40, 42, 44, 88
NSC .....	32, 38, 40
Oak .....	10, 11, 46, 99
Panasonic .....	16, 17, 101
Philips .....	13, 20, 23, 24, 96
Pioneer .....	05, 06, 78
Pulsar .....	04, 30, 42, 44, 52, 63, 85, 88
Radio Shack .....	44
RCA .....	16, 17, 101
Realistic .....	44, 51, 88
Regal .....	14, 41
Regency .....	28
Rembran .....	29, 32, 39, 42, 44, 88
Salora .....	68, 72
Samsung .....	32, 40, 42, 78, 94
Scientific Atlanta .....	08, 09, 56, 61, 87, 90
Sheritech .....	27
SL Marx .....	32, 40, 42, 78, 94
Spucer .....	16, 17, 101
Stargate .....	
..... 04, 30, 32, 40, 42, 44, 52, 63, 78, 85, 88, 94	
Sylvania .....	19
Teknika .....	74
Telecaption .....	77, 92
Televue .....	32, 40, 42, 78, 94
Texscan .....	18, 19
Tocom .....	01, 33, 34, 42, 48, 49, 91
Toshiba .....	36
Uniden Satellite .....	65, 69
Unika .....	01, 29, 44, 88, 91
Universal .....	42, 43, 44, 52, 63, 88
Viewstar .....	13, 20, 22, 26, 40, 58, 62, 98
Videoway .....	07, 23, 50
Vid Tech .....	64
Vidter .....	64
Zenith .....	07, 23, 50

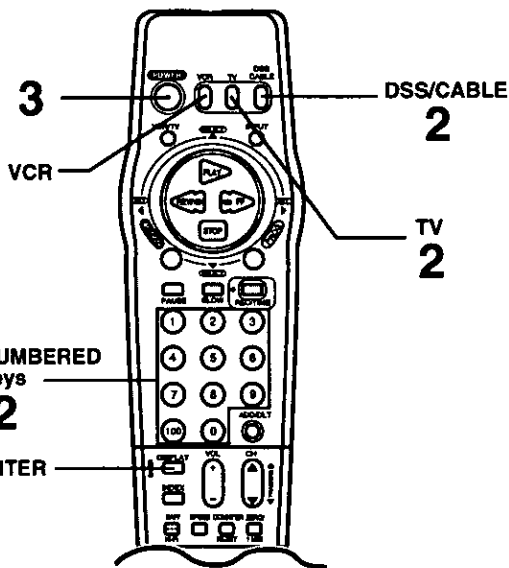

## Multi-Brand Control Setup

- 1 Find your TV or Cable Box or DSS Box Brand Code Number** from one of the charts on this page.
- 2 Hold down TV or DSS/CABLE. Use the NUMBERED keys** to enter your TV or Cable Box Brand code number.
  - For code numbers 100 or greater, first press the 100 key. Then, enter the remaining digit. E.g. for 102, press 100, then press 2.
- 3 To confirm that the correct code was entered, press POWER** to turn your TV or Cable Box or DSS Box On/Off.
- 4 Try each of the functions listed on page 29.**
  - Due to changes in infra-red commands used by some manufacturers, more than one code is listed for some TV or Cable Box brands are listed more than once. If your TV or Cable Box does not respond to the first code, please try entering the next code.



- Please repeat the TV/Cable Box Set Up procedure when you replace the remote's batteries.
- The remote control is designed to control the brands listed. However, it will not operate all TVs, Cable Boxes or DSS Boxes made by these manufacturers. If you get no results, your particular product brand cannot be controlled by this remote control.

# Using the Multi-Brand Control

Once the remote control has been properly set up, you can select VCR, TV, or DSS/CABLE mode depending on which functions you wish to control.

Press **VCR** or **TV** or **DSS/CABLE** on the remote control to select the desired mode. (See below for the controllable functions of each mode.)

## NOTE:

In TV or DSS/CABLE mode, it may be necessary to press **ENTER** after pressing **NUMBERED** keys for channel selection.

## VCR Mode

In VCR mode, the following buttons are available.

### VCR

All function buttons.

### TV

VOL UP/DOWN

## TV Mode

In TV mode, the following buttons are available.

### TV

POWER, INPUT, NUMBERED keys, ENTER, CH UP/DOWN, VOL UP/DOWN

### VCR

VCR/TV, PLAY, STOP, FF, REW, PAUSE, SLOW, REC, SAP/Hi-Fi, SPEED, COUNTER RESET, ZERO/1 MIN.

## DSS/CABLE Mode

In DSS/CABLE mode, the following buttons are available.

### DSS/CABLE

POWER, NUMBERED keys, ENTER, CH UP/DOWN

### TV

VOL UP/DOWN

### VCR

VCR/TV, PLAY, STOP, FF, REW, PAUSE, SLOW, REC, SAP/Hi-Fi, SPEED, COUNTER RESET, ZERO/1 MIN.

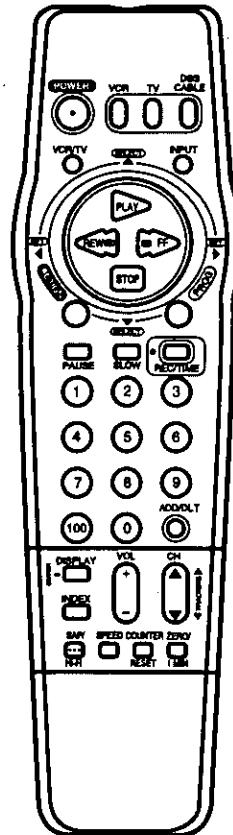
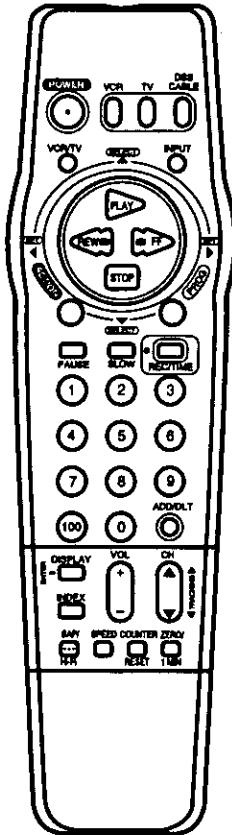
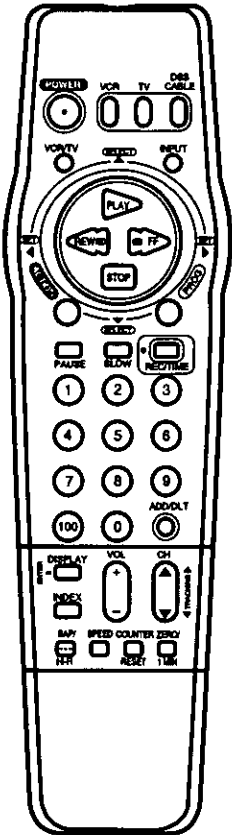

More You Can Do

## NOTES

- Some TV, Cable Box and DSS Box brands require you to turn on the power manually.
- Not all functions listed may be controlled by this remote control.



# Copying Your Tapes (Dubbing)

## Connections you'll need to make.

- When connecting to a normal VCR, use the L Audio In jack for proper sound reproduction.

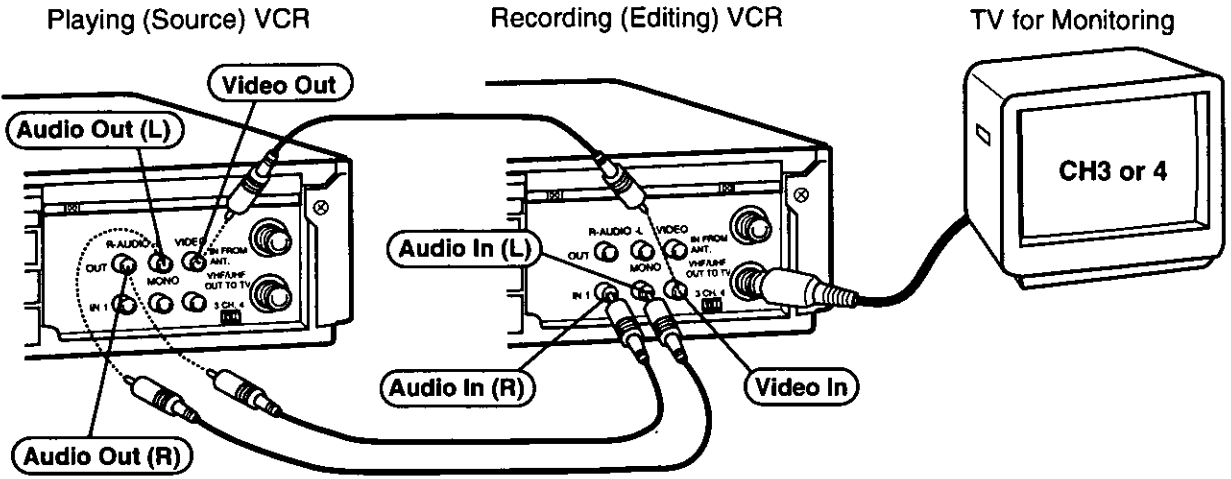

- 1 Insert a pre-recorded tape into the Playing (Source) VCR.

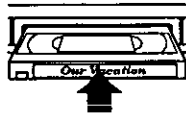

- 2 Insert a blank tape with record tab into the Recording (Editing) VCR.

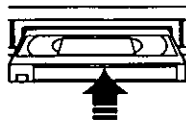

- 3 Select "LINE" input mode on the Recording (Editing) VCR. (See "Selecting the Input Mode" at right.)

- 4 Press PLAY on the Playing VCR. Press PAUSE at the desired starting point.

- 5 Press REC on the Recording VCR, and then press PAUSE immediately thereafter.

- 6 Press PAUSE on both VCRs at the same time, to begin copying.

### To Edit Out Unwanted Parts

Press PAUSE on the recording VCR while copying is in progress. Press PAUSE again to resume copying.

- 7 Press STOP on both VCRs to stop copying.

## To Monitor Dubbing on Your TV

- 1 Turn your TV on and tune to the Recording VCR channel (CH3 or CH4).
- 2 Set the VCR/TV Selector on the Recording VCR to "VCR."

## Selecting the Input Mode

Press INPUT.

The display will change in the order below.

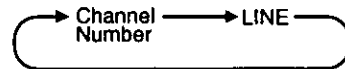

or

Press CH ▲▼.

The display will change in the order below.

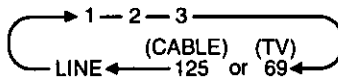

- When LINE is selected, "L" is displayed in the Multi Function Display for about 4 seconds.

### Caution:

Unauthorized exchanging and/or copying of copyrighted recordings may be copyright infringement.



# Before Requesting Service

Check the following points once again if you are having trouble with your VCR.

Power	Correction
No power...	<ul style="list-style-type: none"> <li>• Completely insert the Power Plug into an AC outlet.</li> <li>• Set the POWER button to ON.</li> </ul>
Recording & Playback	Correction
TV program cannot be recorded...	<ul style="list-style-type: none"> <li>• Check connections between VCR, external antenna, and your TV.</li> <li>• Make sure your antenna system (CABLE or TV) is correctly set. (To Replace Channels in Memory [P.14])</li> <li>• Make sure that the record tab is intact on the cassette. (P.5)</li> </ul>
Timer recording cannot be performed...	<ul style="list-style-type: none"> <li>• Set the recording start/stop times correctly. (P.18)</li> <li>• Make sure that the POWER button is set to OFF. (P.18)</li> <li>• Timer recording may not be performed or continued if a power interruption of more than 1 minute occurs before or during, a Timer Recording, even after power is restored.</li> </ul>
There is no playback picture, or the playback picture is noisy or contains streaks...	<ul style="list-style-type: none"> <li>• Select channel 3 or 4 on the TV to match the Channel 3/4 switch located on the rear panel of the VCR. (P.6)</li> <li>• Set the VCR/TV selector to "VCR."</li> <li>• Check that channel 3 or 4 of the TV is properly tuned in.</li> <li>• Adjust the TRACKING control in either direction. (P.16)</li> </ul>
Special effects playback, picture may contain some vertical jitter when using a TV with an Automatic Vertical Hold Control...	<ul style="list-style-type: none"> <li>• Set the TV's Vertical Hold Control to "MANUAL" and then adjust it.</li> </ul>
VCR can not be controlled...	<ul style="list-style-type: none"> <li>• Make sure that VCR LOCK is set to off. (P.22)</li> </ul>
Remote Control	Correction
VCR cannot be remote controlled...	<ul style="list-style-type: none"> <li>• Aim the Remote Control directly at the remote sensor on the VCR.(P.10)</li> <li>• Avoid all obstacles which may interfere with the signal path.</li> <li>• Inspect the remote batteries for possible replacement. (P.4)</li> <li>• Make sure that VCR LOCK is set to off. (P.22)</li> <li>• Exposing the VCR remote sensor to direct fluorescent or outdoor light may cause signal interference.</li> </ul>
ACTION and PROG buttons can not be used...	<ul style="list-style-type: none"> <li>• Press the VCR button to select VCR mode. (P.29)</li> </ul>
Miscellaneous	Correction
Programs cannot be viewed on TV...	<ul style="list-style-type: none"> <li>• Set the VCR/TV selector to "TV." (P.17)</li> </ul>
Video cassette cannot be inserted...	<ul style="list-style-type: none"> <li>• Insert the cassette with window side up; record tab facing you.</li> </ul>
Video cassette cannot be removed...	<ul style="list-style-type: none"> <li>• Completely insert the Power Plug into an AC wall outlet.</li> </ul>
Video cassette ejects when a recording is started or the power is turned off for timer recording...	<ul style="list-style-type: none"> <li>• Make sure the record tab is intact on the cassette. (P.5)</li> </ul>
In Stop mode, the motor (CYLINDER) continues to rotate...	<ul style="list-style-type: none"> <li>• To enable the quick play mechanism, the cylinder will rotate for about 5 minutes. This reduces response time from Stop to Play mode from Play to Rewind Search mode.</li> </ul>
The top of the playback picture waves back and forth excessively...	<ul style="list-style-type: none"> <li>• Because the VCR playback signal is not as stable as an off-the-air TV signal, the top of your TV screen may be bent or unstable during playback. Slowly turn the horizontal hold control on your TV to correct the wavy picture. If your TV does not have a horizontal hold control or adjusting the control does not help, please contact your local TV service center.</li> </ul>

If you cannot resolve the problem, please call the Customer Satisfaction Center for product assistance at 201-348-9090.

To locate an authorized servicer, please call toll free 1-800-211-PANA (7262).

# Service Center List

For Product Information, Operating Assistance, Literature Request, Dealer Locations, and all Customer Service inquiries please contact:

**800-211-PANA (7262)**, Monday-Friday 9am-9pm Saturday-Sunday 9am-7pm, EST.

Web Site: <http://WWW.Panasonic.com>

You can purchase parts, accessories or locate your nearest servicer by visiting our Web Site.

## Factory Servicenters Locations

### CALIFORNIA

6550 Katella Avenue  
Cypress, CA 90630

800 Dubuque Avenue  
S. San Francisco,  
CA 94080

20201 Sherman Way  
Suite 102  
Canoga Park, CA 91306

3878 Ruffin Road  
Suite A  
San Diego, CA 92123

### COLORADO

1640 South Abilene Street  
Suite D  
Aurora, CO 80012

### FLORIDA

3700 North 29th Avenue  
Suite 102  
Hollywood, FL 33020

### GEORGIA

8655 Roswell Road  
Suite 100  
Atlanta, GA 30350

### ILLINOIS

1703 North Randall  
Road  
Elgin, IL 60123  
(Pick-up / Drop-off only)

9060 Golf Road  
Niles, IL 60714

### MARYLAND

62 Mountain Road  
Glen Burnie, MD 21061

### MASSACHUSETTS

60 Glacier Drive  
Suite G  
Westwood, MA 02090

### MICHIGAN

37048 Van Dyke Avenue  
Sterling Heights, MI 48312

### MINNESOTA

7850-12th Avenue South  
Airport Business Center  
Bloomington, MN 55425

### OHIO

2236 Waycross Road  
Civic Center Plaza  
Forest Park, OH 45240

### PENNSYLVANIA

2221 Cabot Blvd. West  
Suite B  
Langhorne, PA 19047

Chartiers Valley  
Shopping Center  
1025 Washington Pike  
Bridgeville, PA 15017

### TENNESSEE

919-8th Avenue South  
Nashville, TN 37203

### TEXAS

7482 Harwin Drive  
Houston, TX 77036

13615 Welch Road  
Suite 101  
Farmers Branch,  
TX 75244

### WASHINGTON

20425-84th Avenue South  
Kent, WA 98032

### HAWAII

99-859 Iwaiwa Street  
Aiea, Hawaii 96701  
Phone (808)488-1996  
Fax (808)486-4369

## Service in Puerto Rico

Matsushita Electric of Puerto Rico, Inc. Panasonic Sales Company/ Factory Servicer:  
Ave. 65 de Infanteria, Km. 9.5, San Gabriel Industrial Park, Carolina, Puerto Rico 00985  
Phone (787)750-4300 Fax (787)768-2910

Accessory Purchases:

Customer Orders Only 800-211-PANA (7262)



# Warranty

Panasonic Consumer Electronics Company,  
Division of Matsushita Electric Corporation  
of America,  
One Panasonic Way  
Secaucus, New Jersey 07094

Panasonic Sales Company,  
Division of Matsushita Electric of Puerto Rico, Inc.  
AVE. 65 de Infantería, Km. 9.5  
San Gabriel Industrial Park  
Carolina, Puerto Rico 00985

## PANASONIC Video Products Limited Warranty

Panasonic Consumer Electronics Company or Panasonic Sales Company (collectively referred to as "the Warrantor") will repair this product with new or refurbished parts, free of charge, in the USA or Puerto Rico, in the event of a defect in materials or workmanship as follows (all time periods commence from the date of the original purchase):

PRODUCT	PARTS	LABOR
CAMCORDER	ONE (1) YEAR, EXCEPT CCD IMAGE SENSOR CCD IMAGE SENSOR - SIX (6) MONTHS	NINETY (90) DAYS NINETY (90) DAYS
VCR	ONE (1) YEAR	NINETY (90) DAYS
A/V MIXER	ONE (1) YEAR	NINETY (90) DAYS
MONITOR-VCR	ONE (1) YEAR, EXCEPT CRT CRT - TWO (2) YEARS	NINETY (90) DAYS CRT - NINETY (90) DAYS CUSTOMER PAYS ALL LABOR CHARGES AFTER 90 DAYS

Monitor-VCR In-home or carry-in Service: 22" (diagonal) CRT / LCD and Larger  
Monitor-VCR Carry-in Service: 21" (diagonal) CRT / LCD and smaller

Batteries (if included) - New rechargeable batteries in exchange for defective rechargeable batteries for ten (10) days. Non-rechargeable batteries are not warranted.

Tape (if included) - New video cassette tape in exchange for a defective video cassette tape for five (5) days.

In-home, carry-in or mail-in service, as applicable, in the USA can be obtained during the warranty period by contacting a Panasonic Services Company (PASC) Factory Servicenter listed in the Service Directory. Or call toll free 1-800-211-PANA (7262), to locate an authorized PASC Servicenter. Carry-in or mail-in service in Puerto Rico can be obtained during the warranty period by calling the Panasonic Sales Company telephone number listed in the Servicenter Directory.

This warranty is extended only to the original purchaser. A purchase receipt or other proof of the date of the original purchase is required before warranty service is rendered.

This warranty only covers failures due to defects in materials and workmanship which occur during normal use and does not cover normal maintenance, including, but not limited to, video and audio head cleaning. The warranty does not cover damage which occurs in shipment, or failures which are caused by products not supplied by the warrantor, or failures which result from accident, misuse, abuse, neglect, mishandling, misapplication, alteration, modification, faulty installation, set-up adjustments, improper antenna, inadequate signal pickup, maladjustment of consumer controls, improper operation, power line surge, improper voltage supply, lightning damage, commercial use such as hotel, office, restaurant, or other business or rental use of the product, or service by anyone other than a PASC Factory Servicenter or a PASC authorized Servicenter, or damage that is attributable to acts of God.

### LIMITS AND EXCLUSIONS

There are no express warranties except as listed above.

THE WARRANTOR SHALL NOT BE LIABLE FOR INCIDENTAL OR CONSEQUENTIAL DAMAGES (INCLUDING, WITHOUT LIMITATION, DAMAGE TO TAPES) RESULTING FROM THE USE OF THIS PRODUCTS, OR ARISING OUT OF ANY BREACH OF THE WARRANTY. ALL EXPRESS AND IMPLIED WARRANTIES, INCLUDING THE WARRANTIES OF MERCHANTABILITY AND FITNESS FOR PARTICULAR PURPOSE, ARE LIMITED TO THE APPLICABLE WARRANTY PERIOD SET FORTH ABOVE. Some states do not allow the exclusion or limitation of incidental or consequential damages, or limitations on how long an implied warranty lasts, so the above exclusions or limitations may not apply to you.

This warranty gives you specific legal rights and you may also have other rights which vary from state to state.

If a problem with this product develops during or after the warranty period, you may contact your dealer or Servicenter. If the problem is not handled to your satisfaction, then write to the Customer Satisfaction Center at the Panasonic Consumer Electronics Company address above.

SERVICE CALLS WHICH DO NOT INVOLVE DEFECTIVE MATERIALS OR WORKMANSHIP AS DETERMINED BY THE WARRANTOR, IN ITS SOLE DISCRETION, ARE NOT COVERED. COSTS OF SUCH SERVICE CALLS ARE THE RESPONSIBILITY OF THE PURCHASER.  
warvid 10/20/97

## Para fijar el idioma , canal y reloj

**1** Encienda el televisor y la videograbadora.

**2** Sintonice el televisor al canal de salida de la videograbadora (el mismo canal que ha fijado en la parte trasera de la videograbadora; canal 3 o 4).

- Si esta usando los terminales de audio/video para su conexión, fije el televisor al modo de entrada de video.

**3** Oprimir CH ▲ para elegir el idioma de la pantalla en inglés.

Oprimir CH ▼ para elegir el idioma de la pantalla en español.

Oprimir VCR/TV para elegir el idioma de la pantalla en francés.

- Ud. podrá fijar también usando los mismos botones que están ubicados en la videograbadora.
- La videograbadora debe conectarse a una antena o caja de TV por cable.

```

SELECT LANGUAGE
PUSH VCR CH ▲: ENGLISH
OPRIMIR VCR CH ▼: ESPAÑOL
APP. VCR/TV : FRANÇAIS
    
```

**4** Oprimir CH ▲ para iniciar la fijación automática de los canales.

- Aparece las siguientes informaciones: "AUTOPROGRAMACION EN PROCESO" "FIJACION AUTOMATICA DEL RELOJ EN PROCESO"

```

FIJACION AUTO. (CA/RELOJ)
CONECTE EL CABLE DE LA
ANTENA Y SI ESTA USANDO
UNA CAJA DE TV POR CABLE
SINTONICE AL CANAL PBS
DE SU LOCAL LUEGO...
POR FAVOR OPRIMIR CH UP
    
```

### Caso 1

```

1/ 4/2000 MAR 12:00PM
HORA VERANIEGA:ACT
CANAL FIJADO : CA 02
FIJACION AUTOMATICA
COMPLETO
TERMINAR : PULSE CH UP
    
```

### Caso 2

```

FIJACION AUTOMATICA
DEL RELOJ
INCOMPLETO
OPRIMIR ACTION
PARA FIJAR EL RELOJ
    
```

### Caso 1

Comprobar si la hora está fijada correctamente y luego oprimir CH ▲ para terminar la fijación.

Si la hora y la hora veraniega es incorrecta, Raras veces, en caso de que ud. vive cerca de dos zonas con hora diferente, el aparato puede elegir un canal PBS con diferente hora de su zona. En este caso, haga los siguientes pasos:

- Tome nota del canal que está fijado en la pantalla y salga desde este modo oprimiendo el botón CH ▲.
- Anule este canal desde los canales memorizados en la combinación de VCR/TV.
- Oprimir el botón ACTION para que aparezca la pantalla del MENU.

**d** Oprimir ▲▼ para elegir "FIJAR RELOJ" y luego oprimir ► para que aparezca la pantalla de "FIJAR RELOJ."

**e** Oprimir ▲▼ para elegir "FIJACION AUTOMATICA" y luego oprimir ► para que aparezca la pantalla de "FIJACION AUTO. (RELOJ)."

**f** Oprimir CH ▲ para iniciar la fijacion automatica.  
• Si ud. esta usando una caja de TV por cable y tiene muchos canales PBS, sintoniza la caja de TV por cable a un canal PBS diferente e intente la fijación automática otravez.

### Caso 2

Si aparece la pantalla anterior, la fijación automática del reloj no es disponible en su zona. Por favor fije la hora del reloj manualmente.

**a** Oprimir el botón ACTION para que aparezca la pantalla de la fijación del reloj.

**b** Oprimir ▲▼◀▶ para elegir y fijar el mes, la fecha, el año, la hora y la hora veraniega.

Para hacer correcciones, Oprimir ◀▶ sucesivamente para mover hasta el paso que desea corregir.

**c** Oprimir el botón ACTION dos veces para iniciar a funcionar el reloj y salir desde este modo.

## Para fijar o fijar de nuevo el reloj

En caso de que el reloj es incorrecto o ha ocurrido un corte eléctrico.

**1** Oprimir ACTION para que aparezca la pantalla del menú.

```

----- MENU -----
PREPARAR VCR
FIJACION DE FUNCIONES
FIJAR RELOJ
FIJAR CANAL
LANGUE/LANGUAGE:ESPAÑOL
ELEGIR:▲▼
FIJAR ►
TERMINAR:ACTION
    
```

**2** Oprimir ▲▼ para elegir "FIJAR RELOJ" y luego oprimir ► para que aparezca la pantalla de "FIJAR RELOJ."

```

----- FIJAR RELOJ -----
FIJACION AUTOMATICA
(MANUAL)
ELEGIR:▲▼
FIJAR ►
TERMINAR:ACTION
    
```

**3** Oprimir ▲▼ para elegir "MANUAL," y luego oprimir ► para que aparezca la pantalla de la fijacion del reloj.

**4** Oprimir ▲▼ y ◀▶ para elegir y fijar la hora y la fecha.

```

-----FIJAR RELOJ-----
1/ 4/2000 MAR 12:00PM
VERANIEGA ON / 1
FIJACION ES COMPLETO
ELEGIR:▲▼
FIJAR ►
TERMINAR:ACTION
    
```

**5** Oprimir ACTION dos veces para iniciar a funcionar el reloj y salir desde este modo.

## Operaciones básicas para la reproducción

- 1 Introducir una cinta
  - Esta indicación aparece en la pantalla multifuncional.

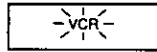

- 2 Oprimir PLAY en el control remoto o en la videograbadora para comenzar a reproducir.

- 3 Oprimir STOP en el control remoto o en la videograbadora para parar la reproducción.

- 4 Oprimir STOP/EJECT para expulsar la cinta.

### Para buscar una escena en particular durante la reproducción

Oprimir REW o FF durante la reproducción para buscar una escena.

- La velocidad de búsqueda es a 7 veces más rápida que la velocidad normal para el modo SP y 21 veces más rápida para el modo SLP.

## Programación fácil para la grabación con temporizador

- 1 Oprimir PROG para exhibir la pantalla de la programación.
  - Si ya existe una programación memorizada, oprimir ▲▼ y ► para elegir un número sin programación.

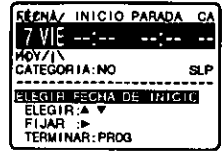

- 2 Oprimir ▲▼ y ► para elegir y fijar uno de los siguientes:

- 1-31 = Grabación de una sola vez
- DIARIO = A una misma hora LUN-VIE
- SEMANAL = Una vez a la semana a una misma hora

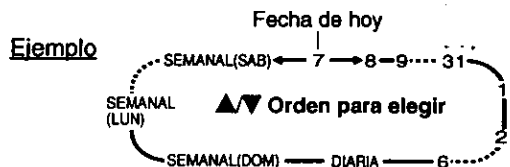

- 3 Oprimir ▲▼ y ◀▶ para elegir y fijar las siguientes fijaciones.

#### Fijaciones:

- Hora de inicio
- Hora de parada
- Canal o LINEA para una fuente externa
- Categoría (NO, DEPORTE, CINE, COMEDIA, MUSICA, DRAMA)
- Velocidad de la cinta (SP, LP, SLP).

#### Para hacer correcciones

Oprimir ► sucesivamente para avanzar u ◀ para retroceder hasta el paso que desea corregir.

- 4 Oprimir PROG para terminar la programación.

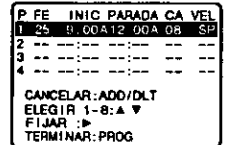

#### Para hacer más programaciones

Oprimir ▲▼ y ► para elegir y fijar un número de programación en blanco y luego repita los pasos 2 y 3.

- 5 Oprimir PROG para salir desde este modo y volver a la pantalla normal.

- 6 Oprimir POWER y apague el aparato para la grabación con temporizador.



- Si la fuente de la grabación es una caja de TV por cable, asegúrese de que la caja de TV por cable esté encendido y esté sintonizado al canal que desea grabar.

Pantalla multifuncional

## Operaciones básicas para la grabación

- 1 Introducir una cinta con la lengüeta.

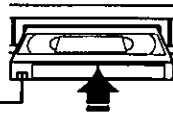

- 2 Oprimir CH ▲▼ o las teclas numéricas para elegir un canal.
  - Para grabar desde una fuente externa, oprimir CH ▲▼ o INPUT para elegir "LINEA."

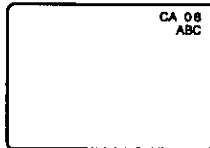

- 3 Oprimir SPEED para cambiar la velocidad de la cinta.

- SP = Reproducción estándar,
- LP = Larga duración,
- SLP = Superlarga duración.

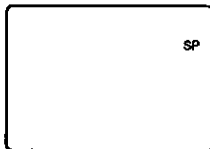

- 4 Oprimir REC/TIME en el control remoto o videograbadora para empezar a grabar.

- Oprimir PAUSE para hacer una pausa en la grabación en progreso.

### Grabación de un toque (OTR)

La videograbadora termina la grabación a una hora programada.

En el paso 4, oprimir repetidamente REC/TIME para fijar el tiempo de grabación. Cada presión cambiará la hora de parada como demuestra al siguiente.

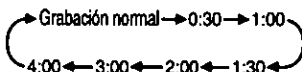

- 5 Oprimir STOP para parar la grabación.

# Quick Use Guide

This guide should only be used once you are familiar with the operations inside this manual. If you have any problems or need more information, please refer to the page listed.

## Clock Reset (page 13)

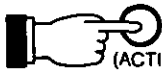
 (ACTION)
 

MENU	
SET UP VCR	
SET UP FEATURE	
<b>SET CLOCK</b>	
SET UP CHANNEL	
ID/OMA/LANGUE: ENGLISH	
SELECT: ▲▼ KEY	
SET: ▶ KEY	
END: ACTION KEY	



SET CLOCK	
AUTO CLOCK SET	
MANUAL	
SELECT: ▲▼ KEY	
SET: ▶ KEY	
END: ACTION KEY	



Display the menu

Select "SET CLOCK"

Select "MANUAL"

SET CLOCK	
1: 2000 TUE 12:00	
05:00	
SET ON	
SELECT HOUR	
SELECT: ▲▼ KEY	
SET: ▶ KEY	
END: ACTION KEY	

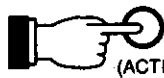

 (ACTION)

Set the clock

Start the clock & exit this mode

## Playback a Tape (page 16)

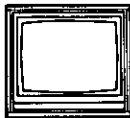
Turn TV on  
 Select VCR  
 Channel 3/4

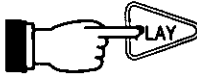

 Insert a tape

 Start playback



 Stop playback



 Eject tape



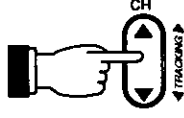

At VCR

## Make a Recording (page 17)

Turn TV on  
 Select VCR  
 Channel 3/4

 Insert a tape with Record Tab



 Select channel





 Select speed

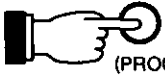

 Start recording

 Stop recording

## Set a Timer Recording (page 18)

 (PROG)
 

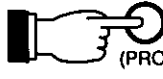
DATE/	START	STOP	CH
7 FRI	---	---	---
TODAY			
CATEGORY: N/A			
SLP			
SELECT: START DATE			
SELECT: ▲▼ KEY			
SET: ▶ KEY			
END: PROG KEY			

 (PROG)
 

P	DT	START	STOP	CH	SPD
1	DAY	9:00A	12:00A	08	ST
2	---	---	---	---	---
3	---	---	---	---	---
4	---	---	---	---	---
CANCEL: ADD/ DLT KEY					
SELECT 1-8: ▲▼ KEY					
ENTER: ▶ KEY					
END: PROG KEY					



Display the program screen

Enter timer information

Once to finish the program, twice to exit this mode

Turn VCR off to set the timer.

Panasonic Consumer Electronics Company, Division of Matsushita Electric Corporation of America  
 One Panasonic Way Secaucus, New Jersey 07094

Panasonic Sales Company, Division of Matsushita Electric of Puerto Rico, Inc. ("PSC")  
 Ave. 65 de Infantería, Km. 9.5 San Gabriel Industrial Park, Carolina, Puerto Rico 00985

